

# **THE SHURE<sup>®</sup> WIRELESS**

## **OPERATORS MANUAL**



**W10BT BODY-PACK TRANSMITTER  
W20R RECEIVER  
WL83 LAVALIER MICROPHONE**

# *Congratulations...*

... ON ACQUIRING ONE OF THE FINEST WIRELESS MICROPHONE SYSTEMS AVAILABLE TODAY. DESIGNED FOR SIMPLE SETUP AND RELIABLE OPERATION, THIS SYSTEM SHOULD PROVIDE YEARS OF DEPENDABLE, TROUBLE-FREE SERVICE. WE STRONGLY URGE THAT YOU READ THIS MANUAL; IT WILL SAVE YOU TIME AND EFFORT, AND ENSURE OPTIMUM SYSTEM OPERATION.

## TABLE OF CONTENTS

The Wireless Microphone .....	3
Frequency Bands .....	3
Multiple Miking .....	4
Directional Sensitivity .....	4
Audio Performance .....	4
With the Transmitter Off .....	4
On Feedback .....	4
Transmitter Range .....	4
System Power .....	4
What Else is Needed .....	4
W10BT Transmitter .....	5
W20R Receiver .....	6
Setup and Connections .....	8
Unpacking .....	8
Receiver .....	8
For Microphone Level Use .....	8
Transmitter .....	8
Microphone Connections .....	8
Instrument Connections .....	9
Battery Check .....	9
Polarity .....	9
Setting Gain Levels .....	10
Transmitter Gain .....	10
Sound Pressure Levels .....	10
Receiver Gain .....	10
Checklist/Operation .....	11
Specifications .....	12
Antennas .....	13
Transmitter .....	13
Receiver .....	13
Receiver-Transmitter Distance .....	13
Batteries .....	14
Troubleshooting .....	15
Accessories .....	16
FCC Certification .....	17
Warranty Service .....	17

# THE WIRELESS MICROPHONE . . . what it is, what it does . . .

The wireless microphone is actually a system consisting of a microphone, a transmitter, and a receiver. The *microphone* is an electroacoustic transducer—a device which converts sound waves (voice, musical instruments, etc.) to electrical impulses, which are sent to the *transmitter*. The transmitter generates a radio-frequency carrier, modulates this carrier with the microphone signals, and radiates this modulated RF signal like a tiny radio station. The *receiver* is matched to the transmitter frequency and picks up the transmitter signal through its antenna. The receiver's circuitry detects the modulated RF signal and converts it to an audio voltage for routing (through a microphone input) to an audio mixer.

At this point, the wireless system acts like any microphone input to a sound system. The figure below shows the complete system, including that which is not a part of the wireless microphone system.

## Frequency Bands.....

Shure wireless transmitters and receivers are single-channel, crystal-controlled units operating at selected frequencies in the VHF-FM band between 150 and 186 megahertz. A total of 10 frequencies, computer-selected for interference-free operation, are readily available, and other frequencies can be ordered on a special basis. This means that up to seven systems can be operated in a single sound installation, simultaneously and without intermodulation problems.\*

\*If more than seven systems are contemplated, Shure recommends the use of DIVERSIPHASE™ wireless microphone receivers.

## Multipath.....

The most troublesome aspect of wireless microphone operation can be a phenomenon known as multipath transmission, or simply, multipath. This appears as a signal “dropout,” with annoying static or complete (although temporary) signal loss. It's caused when the direct signal and a reflected signal—bounced off walls, ceiling, metallic objects, etc.—arrive at the receiver at different times, literally out-of-phase, or when the signal path is completely unobstructed.

You've probably experienced this phenomenon with the FM radio in your car. A dropout location, most likely caused by buildings, mountains, or even telephone poles, causes your radio signal to drop to a low, noisy level—sometimes disappearing completely. This is multipath.

How can multipath be minimized? The following general rules will help achieve optimum wireless microphone operation:

- Maintain line-of-sight transmission (the transmitter wearer should always be able to see the receiver antenna)
- Keep the distance between transmitter and receiver antenna as short as possible
- Avoid RF signal blocking by furniture, scenery, etc.
- Make sure both transmitter and receiver antennas are vertically positioned.
- Don't operate the transmitter with a weak or unsuitable battery

## Multiple Miking.....

More than one wireless microphone system can be used in one sound installation, but each must operate at a different frequency. Shure's complement of 10 standard transmitter-receiver frequencies is generally sufficient for any installation, but additional, special-order frequencies can also be supplied for a nominal service charge.

## Directional Sensitivity.....

The transmitter radiates omnidirectionally, that is, approximately equally in all directions. However, the signal is attenuated by bodies, walls, and other surrounding objects. The receiving antenna is similarly sensitive to radiation from all directions.

## Audio Performance.....

Three important characteristics of high-fidelity audio performance are wide frequency response, low distortion and good signal-to-noise ratio. The Shure wireless system uses high-quality FM circuitry for wide-range frequency response. Distortion is kept to a minimum

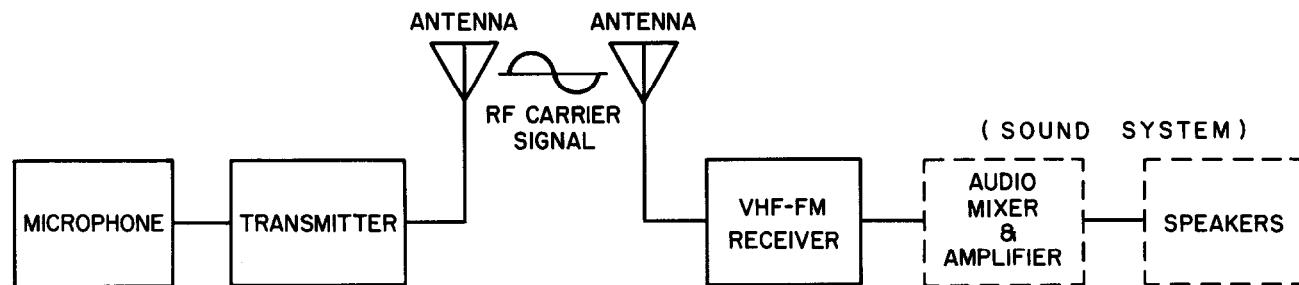

TYPICAL WIRELESS MICROPHONE SYSTEM

through the use of linear-phase IF filtering and high-quality audio circuitry. A high signal-to-noise ratio and wide dynamic range are necessary for noise-free, optimum performance. The Shure wireless uses complementary compression and expansion circuitry in the transmitter and receiver (companding) as well as pre-and de-emphasis to achieve a maximum S/N ratio of 98 dB A-weighted.

#### **With the Transmitter Off.....**

When the wireless microphone transmitter is turned off, the receiver can still receive transmissions from other sources. However, since the Shure system operates in the 150-216 MHz band, it's not susceptible to interference from radio wave skip, or CB or FM broadcast transmissions. The frequencies chosen for use in the Shure system are computer-selected for minimum interference, but it's almost impossible to guarantee a "clear channel" at any location or at any time. (For instance, care must be taken to avoid wireless microphone operating frequencies that are within the bandwidth of locally operating TV channels 7 through 13.)

If the wireless system is to be in a permanent location, it should operate without interference until someone else in the vicinity starts using that frequency. But if the system is to be used in different locations (i.e., "on the road"), occasional frequency conflicts are inevitable. In any case, if the wireless microphone is not in use, the audio mixer gain should be turned down just as with a wired microphone. If the mixer controls are not accessible, turn the receiver off when the transmitter is not in use to prevent unwanted signal pickup. If the system *must* be left on and mixer controls are not accessible, the transmitter should be left on to prevent outside interference pickup.

#### **On Feedback.....**

The use of a wireless microphone doesn't eliminate the possibility of annoying feedback. Feedback control is generally achieved by careful placement of the speakers relative to the microphone, minimum levels necessary for the desired sound, good microphone technique, and proper equalization of the sound system.

#### **Transmitter Range.....**

The FCC-required low power output of the transmitter means that its distance from the receiver should be kept as short as possible. Up to 150 meters (500 feet) should be considered a maximum, although 300-meter (1000-foot) or greater operation is often accomplished.

Reflections, obstacles and interference in a given installation will dictate the system's limits.

Other wireless systems that claim greater distance and flexibility in their operation neglect to state that each installation must be considered separately. A wide variance exists between best- and worst-case conditions.

#### **System Power.....**

The receiver operates from power supplied by a separate ac power converter provided with the system. In addition to 120-volt operation with the power converter, the receiver can be operated from any well-filtered source of 13.5 Vdc at 200 mA. An optional 220-240-volt power converter (WA350) is also available.

The transmitter operates from any 9-volt alkaline transistor-radio-type battery (Duracell MN1604 is recommended). Typical battery life is 8 hours. Inexpensive carbon-zinc batteries are *not* recommended; their extremely short life-about an hour- restricts them to emergency use only. If nickel-cadmium rechargeable batteries are used, they *must* be 8.4-volt (*not* 7.2-volt) types. The lower-voltage batteries will not provide proper transmitter function.

#### **What Else is Needed.....**

In order to make this wireless microphone system operational, the following is needed:

1. A battery for the transmitter.
2. A microphone for the transmitter-either one designed specifically for the wireless transmitter (such as the Shure WL83), or most low-impedance microphones (dynamic, ribbon or condenser) with a microphone adapter cable (WA310). *But* if the wireless system is to be connected to the electrical output of a musical instrument instead of a microphone, a transmitter instrument cable (WA300) must be used.
3. A receiver-to-mixer cable, with a female XLR connector on one end (for the receiver output) and whatever connector is needed for the mixer microphone input on the other.

Optional accessories, useful but not required, are described in this manual.

---

\*IMPORTANT: Other microphones specified as being for wireless microphone use are probably *not* wired for use in Shure wireless systems. Condenser microphones with phantom-powered preamp circuits - Shure SM85, SM87, etc. - will not operate with this transmitter.

# W10BT TRANSMITTER

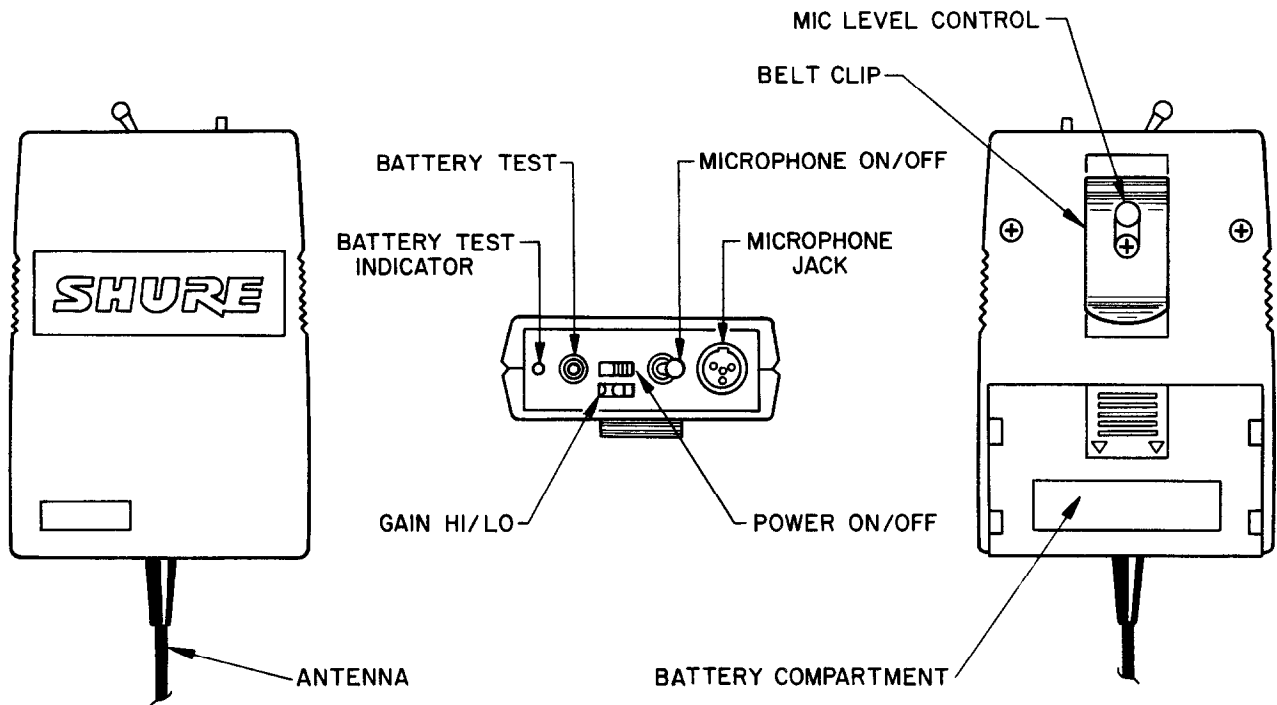

**ANTENNA:** This is a flexible, 1/4-wave vertically polarized antenna approximately 30 cm (12 in.) in length and permanently attached to the bottom surface of the transmitter. For proper operation, the antenna must be in the vertical position; it cannot be coiled or bundled.

**BATTERY (not supplied):** Only alkaline (Duracell MN1604 or equivalent) or heavy-duty nickel-cadmium (8.4-volt) transistor-radio-type batteries should be used. A fresh alkaline battery should provide approximately 8 hours of operation, and a recharged nicad should provide 1-1/2 to 2 hours.

**BATTERY COMPARTMENT:** Slide the cover down to expose the battery compartment. Make certain the battery is installed using the proper positive (+) and negative (-) polarity.

**BATTERY TEST Push-Button Switch:** Permits checking the condition of the installed battery when the power switch is on. The BATTERY TEST LED Indicator will fail to light if the battery is weak or dead (or if the POWER switch is off). Note that if the battery is tested periodically during use, an impending battery failure can be detected: the LED will fail to light at 7.25 volts. At that time, approximately 1 hour of alkaline battery life is left.

**BELT CLIP:** Permits convenient attachment to the user's belt, waistband or other clothing.

**GAIN HI/LO Slide Switch:** Selects the High Gain position to boost the signal of low-output microphones, or

the Low Gain position for high-output microphones or musical instruments. Allows maximum modulation without clipping.

**MICROPHONE JACK:** This is a 4-pin, miniature, male Tini Q-G connector designed to mate with Switchcraft TA4F or equivalent connectors. A built-in 20-kilohm load resistor provides proper matching for dynamic, ribbon or condenser microphones. Connector pin 2 supplies +5-volt bias voltage for condenser microphone phantom powering. In addition to microphones with TA4F connectors, Shure has available an adapter cable with a standard XLR female connector for use with conventional microphones (WA310), and a musical instrument adapter cable with a 1/4-inch phone plug on the equipment end (WA300).

**MICROPHONE LEVEL Rotary Control:** In conjunction with the GAIN HI/LO switch, this control provides additional audio level adjustment. A small screwdriver is supplied to make adjustments.

**MICROPHONE ON/OFF Toggle Switch:** Permits the user to "mute" the microphone without turning the transmitter off. This avoids the "pop" that may accompany power turn-on and turn-off, and generally prevents pickup of unwanted signals by the receiver.

**POWER ON/OFF Slide Switch:** Applies power to the transmitter circuitry. The switch is a low-profile type to minimize accidental turn-off.

# W20R RECEIVER

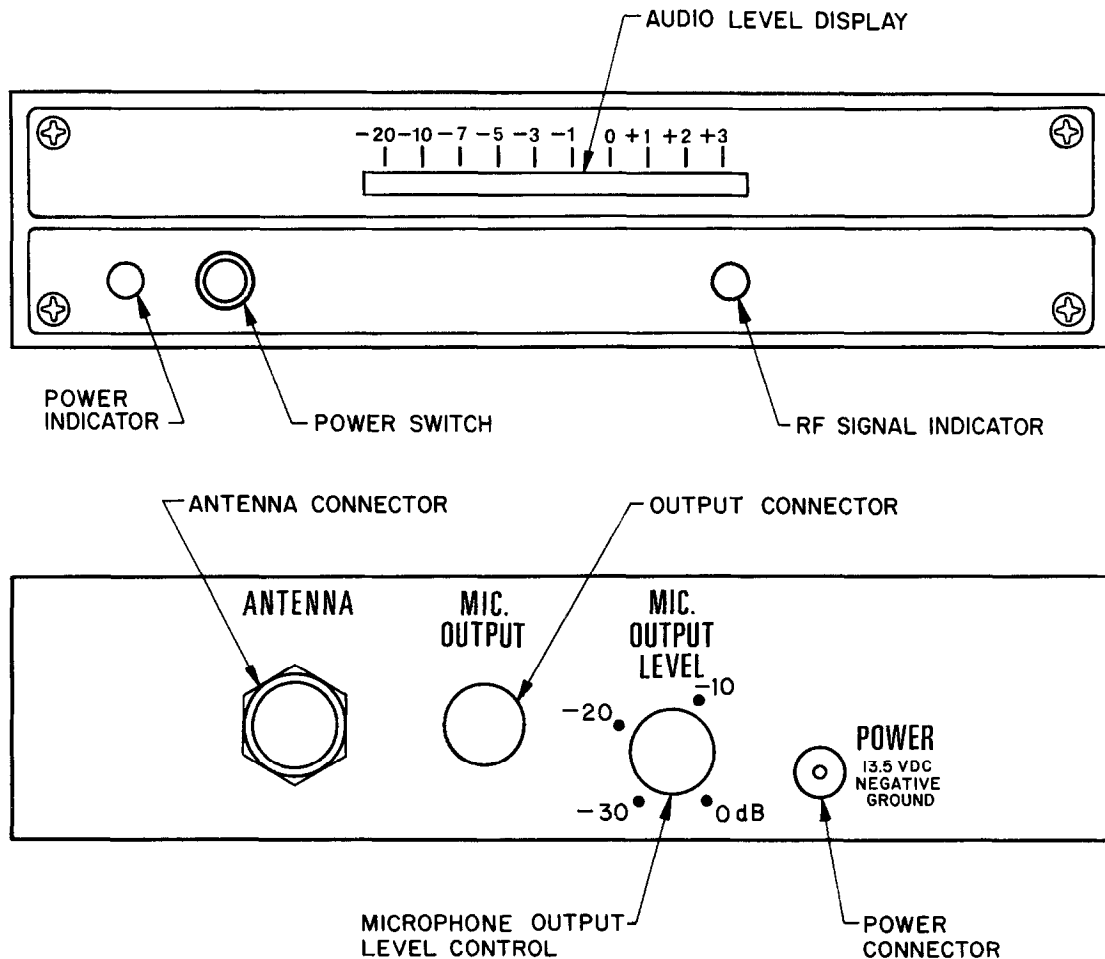

## FRONT PANEL

**POWER Push-Button Switch:** Applies power from the external power converter or other well-filtered 13.5 Vdc (200 mA) sources to the receiver circuitry. An adjacent green POWER LED Indicator remains on while power is applied. (NOTE: With the power converter connected to a 115 Vac, 60 Hz source, 13.5 Vdc is present at the power converter output.)

**AUDIO LEVEL Display:** This IO-LED bar display indicates the relative system modulation. Normal operation is shown by illumination of the green portion of the display, with occasional excursions into the yellow. If frequent or constant yellow or red indications are observed, the transmitter MICROPHONE LEVEL control should be lowered (counterclockwise), or the Gain switch set to the Lo position. The display is calibrated in volume units (VU).

**RF SIGNAL LED Indicator:** This yellow indicator lights to show that the receiver is picking up the transmitted signal. Note that the LED is not an indicator of signal strength (the LED will light through a range of marginal through strong signal conditions), but a flickering LED generally indicates barely acceptable operation, and no indication means that no signal is being received. The receiver contains a squelch circuit to eliminate unwanted signals or noise in the absence of wireless transmitter signals. The squelch circuit is not user-adjustable; it is preset to an optimum threshold setting of 1.0  $\mu$ V, minimizing setting errors and difficulties in returning the squelch to its original setting. The yellow RF LED does not light when the squelch circuit is activated.

## REAR PANEL

**ANTENNA UHF-Type Connector:** Provides for connec-

tion to the 1/4-wave vertical antenna supplied with the W20R (or the optional WA250 5/8-wave antenna, which provides up to 3 dB additional RF gain). If the receiver is to be mounted in a shielded rack mount enclosure or other area which may interfere with RF wave reception, the 7.6m (25 ft) coaxial cable (WA280) permits remote antenna placement, and the WA250 can be attached to a microphone stand or wall mounted using the optional bracket (WA260). (NOTE: Remote placement of the 1/4-wave antenna using the WA280 coaxial cable requires a female-to-female PL258-type UHF adapter.)

**MICROPHONE OUTPUT LEVEL Rotary Control:** This control determines the signal level at the OUTPUT Connector. Using this control, the signal level can be matched to that of a conventional wired microphone.

**POWER 13.5 VDC NEGATIVE GROUND Coaxial Jack:** This connector accepts power from the supplied power converter, or from any well-filtered 13.5 Vdc (200 mA) supply.

**MIC OUTPUT 3-Pin XLR Connector:** Provides balanced, low-impedance output for connection to the audio mixer or amplifier.

#### **INTERNAL**

For access to the internal power fuse, remove four screws at the sides, and two at the top front and rear.

**FUSE 1/2A:** This is a 0.5 ampere, 250-volt, 3AG-type, fast-blow fuse that protects the power supply from excessive current. It should be replaced *only* with a fuse of identical size and value (Littelfuse 312.500 or equivalent).

# SETUP AND CONNECTIONS

## UNPACKING

Unpack all units and parts of the Wireless Microphone System. If possible, retain packaging in the event of returning a unit for repair. Check all boxes and inner packaging; if any damage or shortage is discovered, refer to the Warranty Service section of this manual.

## RECEIVER

Place the W20R receiver in its operating location and connect the supplied power converter to the rear-panel POWER Jack. Connect the power converter to a 105 to 125 Vac, 60 Hz power source.

Attach the 1/4-wave whip antenna to the receiver ANTENNA connector. Make certain it is pointed upward. **IMPORTANT:** The receiver antenna should be within the line-of-sight of the transmitter's operating area. Obstructing or reflecting objects will degrade wireless microphone performance.

If desired, the receiver can be mounted in a rack panel kit (WA210) for mounting in a standard 19-inch audio equipment rack.

### For Microphone Level Use

Obtain an XLR-type balanced low-impedance audio connecting cable and connect it between the W20R MIC OUTPUT Connector and the mixer or amplifier microphone-level input (see Figure 1). Adjust the levels as described under Level Adjustment.

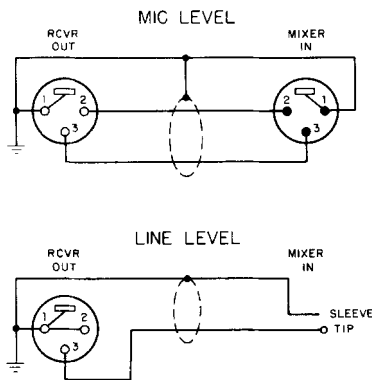

RECEIVER-MIXER CABLE  
FIGURE 1

## TRANSMITTER

With the transmitter POWER ON/OFF Switch in the OFF position, slide the battery compartment access cover down and off the transmitter case. Insert a new 9-volt transistor-radio-type battery (Duracell MN1604 or

equivalent) in the compartment. Observe the proper polarity: the large (negative) terminal in the large channel and the small (positive) terminal in the small channel. Operation with a full charged, heavy-duty, 8.4-volt nickel-cadmium rechargeable battery is also permissible. **IMPORTANT:** Do not use a "conventional" 9-volt-sized nickel-cadmium battery; its 7.2-volt output will operate the transmitter for about 15 minutes. Carbon-zinc batteries will also result in diminished operating life (about 1 hour).

## Microphone Connections

The Shure WL83 lavalier condenser microphone or similar microphones with identical wiring and a Switchcraft TA4F type connector can be plugged directly into the transmitter microphone jack. The WL83 will operate using the transmitter's regulated +5 Vdc available on pin 2 (see Figure 2). Self-powered (battery) condenser microphones can be used with the transmitter *only* if they can be operated in an unbalanced mode (one side grounded). Other non-self-powered condenser microphones may require special wiring; contact Shure's Service Department for further information. Phantom-powered condenser microphones will not operate with the W10BT.

A high- or low-impedance dynamic or ribbon microphone with pin 2 output can be directly connected to the transmitter using the supplied WA310 microphone adapter cable. The cable has a 3-socket XLR connector on the microphone end and a Switchcraft TA4F connector on the transmitter end, and is wired for unbalanced low-impedance operation only (see Figure 2). Shure high-impedance microphones are not wired to operate with the transmitter. If a Shure high-impedance microphone must be used, pins 2 and 3 should be reversed (by qualified service personnel). Using a low-output, low-impedance dynamic lavalier microphone such as Shure's SM11 may require raising the mixer input gain appreciably, which in turn may result in an increase in noise and signal "pumping."

## Instrument Connections

To connect the transmitter to a guitar or other musical instrument pickup, obtain an instrument adapter cable such as Shure's WA300. This cable has a 1/4-inch phone plug on one end and a Switchcraft TA4F on the other (see Figure 2), and should function normally with any high-impedance instrument pickup.

## Battery Check

Turn the transmitter power on and depress the BATTERY TEST Switch. The adjacent LED should light, indicating adequate transmitter input voltage. If the LED does not light, the alkaline battery voltage has dropped



TRANSMITTER CONNECTOR



- 1 - GROUND
- 2 - +5 VDC
- 3 - AUDIO
- 4 - 20K TO GROUND

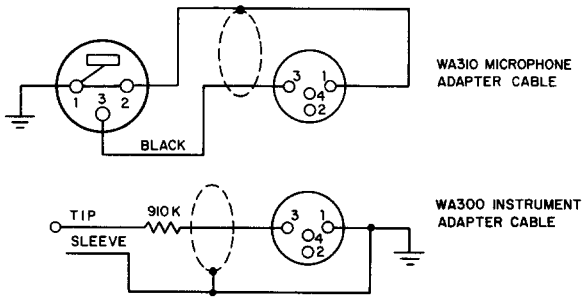

TRANSMITTER CONNECTIONS AND ACCESSORY WIRING

FIGURE 2

below 7.25 volts and the battery should be replaced or recharged (nicad only).

If the battery is tested periodically, the failure of the LED to light indicates approximately one hour-of battery life left (alkaline only).

**Polarity**

With the Shure WL83 or a Shure low- or high-impedance XLR-connector microphone connected through a WA310 cable, positive pressure on the microphone diaphragm results in positive voltage on pin 2 with respect to pin 3 of the receiver OUTPUT connector. Negative voltage applied to the tip of a WA300 cable will result in the same output polarity.

# SETTING GAIN LEVELS

With the system in place and connected, all units can now be turned on and the levels set to their optimum positions.

## TRANSMITTER

Place the POWER Switch of the W20R receiver in the ON position. The green POWER LED will light.

Turn the transmitter POWER ON/OFF Switch on. Observe the receiver yellow RF SIGNAL LED. It should be continually lit, indicating adequate RF signal strength for good transmission. If the LED continually flickers or does not light, consult the Troubleshooting section of this manual.

Turn the transmitter MIC ON/OFF Switch to the ON position. With a microphone connected to the transmitter, the receiver AUDIO LEVEL display will now respond to varying sound levels.

Set the transmitter GAIN Switch as dictated by the type of input: Hi for low-impedance microphones; LO for high-impedance microphones and instrument pickups.

## Sound Pressure Levels

**Normal.** The transmitter MIC LEVEL Control has been factory-set to provide optimum audio modulation at the receiver, as indicated by LED illumination in the -7 to 0 range (see Figure 3). Readings in this area will yield the highest dynamic range without overload and resulting distortion.

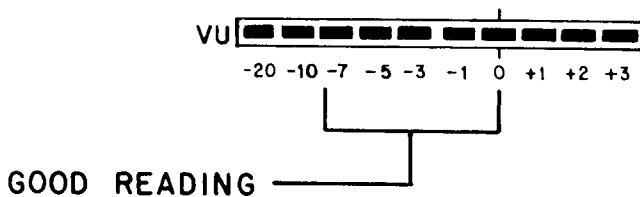

AUDIO LEVEL DISPLAY  
FIGURE 3

**High.** For high sound pressure level (SPL) applications such as loud singing or musical instruments, the preset transmitter level may be too high. To avoid this overload and potential distortion condition, use the supplied screwdriver to turn the transmitter MIC LEVEL Control down (counterclockwise; see Figure 4). This adjustment should be made under the expected operating conditions, that is, with the high SPL singer or musical instrument in use at the microphone. Turn the control down until the optimum (-7 to 0) readings are obtained.

**Low.** Low SPL applications such as soft-spoken individuals or conditions where the microphone must be at a greater-than-normal distance from the sound source,

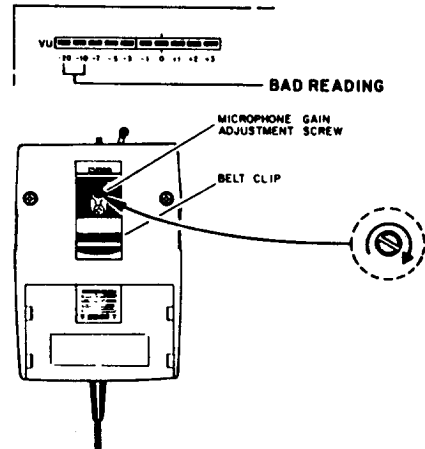

HIGH SPL GAIN ADJUSTMENT  
FIGURE 4

may require an increase in the transmitter gain setting. To correct for a low-level condition, turn the MIC LEVEL Control up (clockwise; see Figure 5) until a proper (-7 to 0) LED reading is obtained.

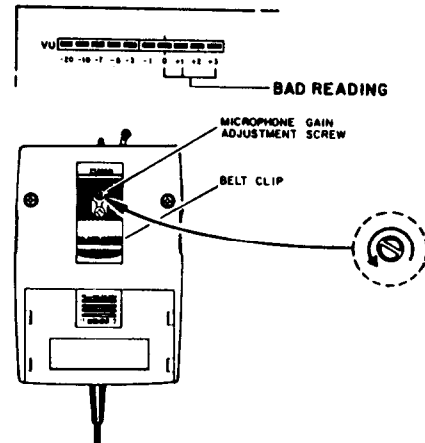

LOW SPL GAIN ADJUSTMENT  
FIGURE 5

## RECEIVER

The rear-panel receiver OUTPUT can be adjusted using the MICROPHONE OUTPUT LEVEL Control. In this way, the wireless system output can be made identical to that of a conventional wired microphone, avoiding extreme differences in input level settings. Turning the MICROPHONE OUTPUT LEVEL Control counterclockwise decreases the output level, and turning it clockwise increases the output.

# CHECKLIST/OPERATION

## CHECKLIST

The following checklist shows the status of your wireless microphone system at this point. If the following steps have been performed and the expected results obtained, the system can be put in operation.

- Is the receiver properly located?
- Is the power converter connected to the receiver? Is ac power present?
- Is the antenna connected to the receiver?
- Is the receiver connected to the rest of the sound system?
- Is a fresh battery installed in the transmitter?
- Is a microphone of the proper impedance and wiring being used?
- Is the microphone or instrument connected to the transmitter?
- Has the transmitter gain been set properly?
- Have the transmitter and transmitter antenna been properly positioned?
- Is the receiver output level properly set?

## OPERATION

1. Turn on the transmitter and receiver POWER Switches.
2. Make sure the transmitter MIC ON/OFF Switch is on.

3. Talk into the microphone (or play the connected musical instrument) and observe the receiver display for proper audio and RF indications.
4. Continue talking or playing and move around the performing area. In each area, observe the receiver displays and make sure the RF signal strength is adequate.

In most cases, the problem of weak RF signal strength is also indicated by audible evidence: signal dropout, either continuous or intermittent, or noisy, distorted operation. The condition is generally caused by poor antenna location, RF signal blocking, or operation beyond the system capability. Refer to the Troubleshooting section for remedies.

Normal operation is shown by steady illumination of the yellow RF SIGNAL LED. A weak RF signal is indicated by intermittent lighting of the LED, as well as by audibly poor sound quality.

Feedback-the annoying howl or squeal heard in the sound system- is as much a problem in wireless microphones as in wired mics. Checking microphone operation throughout the performing area will probably uncover any locations that are prone to audio feedback. If the problem cannot be solved by a slight lowering of the receiver output level or the associated amplifier gain, relocation of the speakers or possibly professional equalization of the sound system is recommended.

### IMPORTANT

Every wireless microphone installation is a unique situation, and can present a variety of problems. Never attempt a live performance without a "walkthrough" first. And if major changes (furniture, scenery, etc.) were made since the walkthrough, check the wireless microphone operation again.

# SPECIFICATIONS

## SYSTEM

### RF Carrier Frequency

150 to 216 MHz (10 frequencies between 167.875 and 183.0 MHz offered; others available)

### Frequency Stability

0.005%, Crystal-Controlled

### Ultimate Quieting (ref. 12 kHz deviation)

>90 dB at 30m (100 ft); 60 dB, line-of-sight at 402m (1/4 mi.)

### Modulation

± 12 kHz deviation compressor-expander system with pre- and de-emphasis

### Distortion (ref. 12 kHz deviation)

Less than 0.3% THD, 50-15,000 Hz

### Dynamic Range

98 dB A-weighted

92 dB unweighted

### Audio Frequency Response

50 to 15,000 Hz, ± 1 dB

### Audio Polarity

Positive pressure on microphone diaphragm results in positive voltage on pin 2 with respect to pin 3 of OUTPUT connector (with Shure WL83 or Shure low- or high-impedance, XLR-connector microphone through WA310 cable); negative voltage applied to tip of WA300 cable connector results in same output polarity

### Temperature Range

Receiver . . . . . - 18° to 54°C (0° to 130°F)

Transmitter (alkaline batt.) . 0° to 38°C (32° to 100°F)

Transmitter (mercury batt.) . 4° to 54°C (40° to 130°F)

Transmitter (carbon-zinc) . . . 7° to 32°C (45° to 90°F)

### Certification

Type-accepted under FCC Parts 90 and 74  
(FCC ID DD48NJW20R)

## RECEIVER

### RF Sensitivity

Less than 0.5 µV for 12 dB SINAD

### Image Rejection

At least 75 dB

### Spurious Rejection

At least 80 dB

### Squelch Quieting

125 dB

### Squelch Threshold

Internally preset to 1.0 µV

### Output

-20 dB across 200 ohms maximum (mic level adjustable)

### Antenna Input Impedance

50 ohms nominal

### Antenna

1/4 wavelength, 457 mm (18 in.) whip, UHF connector

### Power

13.5 Vdc nominal (negative ground); 200 mA external power converter supplied

### Dimensions

42.8 mm H (plus feet) x 190 mm W x 173 mm D (1-11/16 in. x 7-1/2 in. x 6-13/16 in.) (depth is 190 mm—7-1/2 in. including controls and connectors)

### Weight

723 grams (1 lb 9-1/2 oz)

## TRANSMITTER

### RF Power Output

50 mW maximum; 30 mW typical

### Modulation

54F3 ± 12 kHz deviation, 50 µsec pre-emphasis

### Modulation Limiter

internal compressor

### Input Impedance

Actual: 16k (20k dc), pin 4 wired to pin 3 for WL83 microphone; 91k, pin 4 open for microphone or instrument pickup

### Gain Switch

High position . . . . . 0.0065 Vrms required for 100% modulation

Low position . . . . . 0.065 Vrms required for 100% modulation

### Gain Adjustment Range

Low Position . . . . . 20 dB

High Position . . . . . 30 dB

### Antenna

Attached, 305 mm (12 in.), omnidirectional, flexible wire

### Power

Battery Type . . . . . 9-volt alkaline (NEDA 1604A); 8.4-volt nicad optional

Battery Life . . . . . 6 to 8 hours typical (alkaline); 1.5 to 2 hours typical (8.4-volt nicad; per charge)

Current Drain . . . . . 35 mA typical

### Dimensions

102 mm H x 69.8 mm W x 25.4 mm D (4 in. x 2-3/4 in. x 1 in.) (not including antenna, controls and belt clip)

### Weight

113 grams (4 oz); 170 grams (6 oz) with battery

# ANTENNAS

## TRANSMITTER

The transmitter antenna is a permanently attached, flexible wire, 1/4-wave antenna. It has an omnidirectional transmission pattern (equally effective in all directions) and is designed to operate in a vertically polarized mode. This means that the antenna should hang downward during operation; coiling or wadding it to minimize visibility will reduce the system's operating distance.

## RECEIVER

The receiver antenna is a single-section, 1/4-wave whip antenna approximately 457 mm (18 in.) in length. Like the transmitter antenna, the receiver antenna has an omnidirectional pickup pattern and are vertically polarized. Vertical mounting is a requirement for optimum pickup.

For "problem" installations, improved performance may be obtained using an optional 5/8-wave whip antenna (WA250). Up to 3 dB gain increase can be realized with this antenna over the standard 1/4-wave.

Also available for use with the 5/8-wave antenna are a 7.6m (25 ft) coaxial cable (WA280) for remotely locating the antenna (necessary where the receiver is to be mounted in a shielded rack mount enclosure or other poor RF location), and a wall-mount bracket (WA260) for affixing the antenna to a variety of surfaces. The 5/8-wave antenna can also be mounted on a conventional microphone stand using a microphone swivel adapter such as the Shure A25B or A25C.

## RECEIVER-TRANSMITTER DISTANCE

Observing the following rules regarding transmitter to receiver antenna distance will yield the best results possible.

Keep the transmitter to receiver antenna distance as short as possible. As the distance increases, the transmitted signal is weaker (see Figure 6).

Make certain the signal path between the transmitter and the receiver antenna is unobstructed. The transmitter wearer should be able to visually locate the receiver antenna at any time (see Figure 7).

Try to avoid operating the system through or around walls, ceilings, metal objects, etc. The usual result is reduced range and performance, and the signal reflections off metal obstructions will not only cause reduced signal, but will introduce the problem of multipath distortion (see Figure 8).

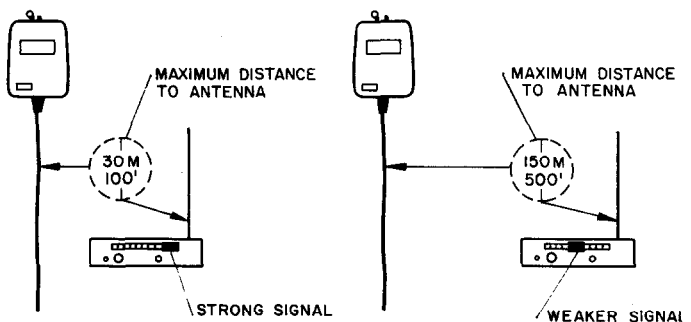

TRANSMITTER-RECEIVER DISTANCE  
FIGURE 6

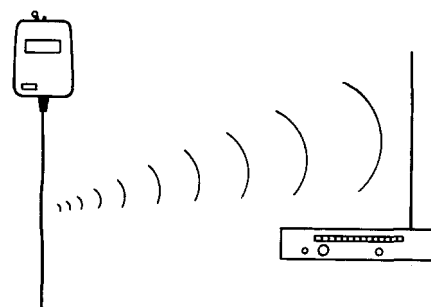

LINE-OF-SIGHT TRANSMISSION  
FIGURE 7

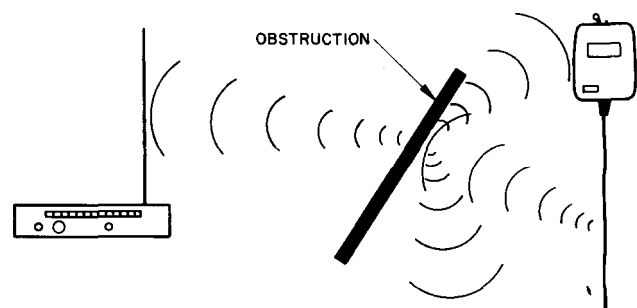

OBSTRUCTION EFFECTS  
FIGURE 8

# BATTERIES

Careful transmitter battery selection, installation, use and care will help avoid problems in wireless microphone use. The most dependable, long-lived batteries at this time are the manganese-alkaline, or alkaline, types. In addition to offering the longest expected operating life, they are commonly available.

One small word of caution about alkaline batteries: they are not all the same size. Make certain the battery you buy will make contact inside the battery compartment.

Nickel-cadmium (nicad) batteries can save money through their rechargeability, but the tradeoff is in shorter expected life per charge. In addition, forgetting to recharge can be disastrous.

Another major consideration in nicads is that of operating voltage. The "heavy-duty" 8.4-volt nicads are satisfactory for transmitter use, but the "9-volt-size" nicads commonly found in stores are only 7.2 volts and will not provide satisfactory wireless performance.

Mercury batteries in the "g-volt-size" are also actually 8.4 volts. However, their discharge characteristics are such that they will yield between 10 and 15 hours of operation with the transmitter.

Carbon-zinc batteries are the least useful for transmitter operation. Their low cost is more than offset by their extremely short operating and shelf life. Although the "heavy-duty" (HD) carbon-zinc types offer better low-temperature performance and service capacity at moderate to high current drain, they will not offer appreciably better transmitter performance than standard carbon-zinc batteries.

Although battery operation is inhibited at low temperatures, storing batteries at low temperatures will increase their shelf life. They should be sealed in bags and, when ready for use, allow to warm up to room temperature (never heated!). Cold-stored batteries should be used as soon as possible after bringing to room temperature.

Battery life is shortened by high-temperature storage such as on amplifiers or in vehicles exposed to direct sunlight.

## RECOMMENDED RANGES

	Alkaline	Mercury	Carbon-Zinc	Nicad
Temperature	0° to 38°C (32° to 100°F)	4° to 54°C (40° to 130°F)	7° to 32°C (45° to 90°F)	-20° to 45°C (-4° to 113°F)
Shelf Life (room temperature; to 80% of capacity)	30 months	30 months	6 to 12 months	10 to 80 days

The battery should be removed if the transmitter malfunctions, or if it is to be stored for a long period. Most batteries have a protective jacket, but partly or completely exhausted batteries are more prone to leakage.

Do not attempt to recharge replaceable (primary) batteries using "chargers", heat or other methods. This may cause leakage or explosion. Do not disassemble batteries or dispose of them in fire.

BATTERY TYPE	MANUFACTURER & NO.	VOLTS	EXPECTED LIFE
Alkaline	Bright Star 7590 Duracell MN1604 ESB A1604 Eveready 522 IEC 6LF22 NEDA 1604A Panasonic 6AM6 Radio Shack 23-553 Ray-O-Vac A1604 U.S. Military BA3090 Varta 4022	9.0	6 to 7 hours
Mercury	Burgess H146X Duracell TR146X Eveready E146X NEDA 1604M Panasonic TR146 US. Military BA1090/U	8.4	10 to 15 hours
Nickel-Cadmium	SAFT PS-9 Varta TR7/8	8.4	1-1/2 to 2 hours per charge
Carbon-Zinc	Duracell M1604 Eveready 216 Ray-O-Vac 1604 Radio Shack 23-464	9.0	1 hour
Carbon-Zinc (Heavy Duty)	Duracell M1604HD Eveready 1222 Ray-O-Vac D1604 Radio Shack 23-583	9.0	1 hour

# TROUBLESHOOTING

If you encounter any problems in the operation of your Shure Wireless Microphone System, first make certain you've followed the ABC's of proper wireless microphone operation:

- Antennas** - Make certain the transmitter antenna is dangling vertically. Make certain the receiver antenna is properly connected, located and mounted.
- Battery** - Make certain the transmitter battery is fresh and of the right type. And while you're at it, make certain the receiver power converter is connected to a functioning power source.
- Controls** - All receiver and transmitter controls should be properly set for the desired operation. Recheck all settings for correct system setup.

If you still have a problem, follow the advice below. If you're unable to solve the problem, contact your dealer or Shure's Service Department.

PROBLEM	SOLUTION
Movement around the performing area produces intermittent "swooshing" sound or complete loss of signal (dropout).	Make certain the antenna is properly connected, mounted and positioned for optimum reception. Minimize transmitter-to-receiver distance.
Audio signal sounds distorted at medium to high input levels.	Reduce transmitter audio gain.
Receiver picks up other (interfering) radio signals.	Make certain transmitter is turned on. If problem persists with transmitter on, it may be necessary to change system operating frequency. (Another transmitter, possibly a VHF-TV transmitter, may be operating at the same frequency.)
Audio signal contains undesirable whistling or chirping sounds, or sounds garbled.	Two transmitters may be operating simultaneously on the same frequency. Turn one transmitter off. If problem persists, may be caused by other radio signals (see above).
Audio signal contains undesirable hissing sounds.  One wireless microphone produces a lower output than other wireless microphones in the same sound system.	Transmitter and/or receiver gain may require increase (setting is too low).
Movement around the performing area produces an undesirable squeal or howl (feedback).	Relocate the speakers. Reduce the receiver and/or and/or sound system gain. (Professional equalization may be required.)
Maximum operating distance (transmitter to receiver antenna) seems less than when system was new.	Transmitter antenna may require replacement. Receiver antenna may require relocation.
Short transmitter battery life.	Make certain replaceable batteries are alkaline (Duracell MN1604 or equivalent). Make certain rechargeable batteries (nicads) are 8.4-volt types.
Receiver not functioning.	Make certain receiver power converter is connected to functioning ac source.  Make certain internal 0.5A, 250V, 3AG fuse is not blown. (Disconnect from ac source, remove four side, two front and two back screws for access to fuse.)

**REMEMBER:** Many apparent problems are due to improper setup and operation. Make certain you have followed instructions carefully before contacting Shure for service.

# ACCESSORIES

The following Shure Wireless System accessories are available through your Shure dealer. (Replacement parts can be ordered from Shure's Service Department; information is available from Shure's Service Department.)

## **MODEL WL83 LAVALIER CONDENSER MICROPHONE**

– This is a tiny electret condenser microphone designed for high-quality sound reproduction in broadcasting, film and sound reinforcement applications. The WL83 plugs directly into the W10BT transmitter, and is supplied with a variety of mounting options.

## **MODEL WA200 SINGLE RECEIVER RACK MOUNT KIT**

– This kit consists of a metal front panel and hardware for mounting one W20R receiver in a standard 19-in (483 mm) audio equipment rack.

## **MODEL WA210 DOUBLE RECEIVER RACK MOUNT KIT**

– Similar to the WA200, this kit permits mounting two W20R receivers side by side in a standard 44.5 mm x 483 mm (1-3/4 x 19 in.) rack space.

## **MODEL WA250 5/8-WAVE WHIP ANTENNA**

– This 3-section whip antenna is an optional replacement for the 1/4-wave antenna supplied with the W20R receiver. It comes with a right-angle UHF adapter.

## **MODEL WA260 ANTENNA WALL-MOUNT BRACKET**

– This bracket is for use with the optional 5/8-wave antenna. It comes with mounting hardware.

## **MODEL WA280 COAXIAL ANTENNA CABLE**

– This 7.6m (25 ft) coaxial cable can be used with either the

1/4-wave or the optional 5/8-wave receiver antenna to locate the antenna at a distance from the receiver.

## **MODEL WA300 INSTRUMENT CABLE**

– This is a 1.2m (4 ft), single-conductor, shielded cable with a 1/4-inch phone plug on one end and a Switchcraft TA4F on the other. It is used for connecting the W10BT transmitter to a guitar or other musical instrument pickup.

## **MODEL WA310 MICROPHONE CABLE**

– A 1.2m (4 ft), single-conductor, shielded cable with a 3-socket (female) XLR connector on one end and a Switchcraft TA4F on the other. The WA310 is designed to connect the W10BT to a low-impedance dynamic or condenser microphone for unbalanced operation (pin 3 of the XLR connector is "hot").

## **MODEL WA320 AC POWER CONVERTER**

– This is a replacement for the 120 Vac power converter supplied with the W20R receiver.

## **MODEL WA330 MICROPHONE CONNECTOR**

– This TA4F miniature connector permits microphones such as the Shure SM10A or SM98 to be connected directly to the W10BT transmitter.

## **MODEL WA340 1/4-WAVE WHIP ANTENNA**

– This is a replacement for the 1/4-wave whip antenna supplied with the W20R receiver.

## **MODEL WA350 AC POWER CONVERTER**

– Similar to the WA320, this power converter permits operation at 220 to 240 Vac.



# FCC CERTIFICATION

The Shure Model W10BT transmitter is Type-Accepted under Federal Communications Commission Parts 90 and 74. The Shure Model W20R receiver is Type-Accepted under FCC Part 15. Licensing of Shure wireless microphone equipment is the user's responsibility, and licensability depends on the user's classification and application, and on the selected fre-

quency. Shure strongly urges the user to contact the appropriate telecommunications authority before choosing an ordering frequencies other than factory-preset frequencies. This recommendation applies to both original equipment purchase and subsequent frequency modification by Shure.

# WARRANTY SERVICE

If your Shure wireless microphone equipment should require servicing under the Shure warranty, please contact:

Shure Brothers Inc.  
Attention: Service Department  
222 Hartrey Avenue  
Evanston, Illinois 60202-3696 U.S.A.  
Telephone: (312) 866-5730

All claims of defects or shortage should be directed to the above address. Please furnish model number, operating frequency, and date, place and proof of purchase (such as a copy of the sales receipt) to establish warranty. Your letter should include all pertinent details including applicable model or part numbers and a brief description of the problem. Do *not* return any units or parts to Shure unless requested to do so by Shure's Service Department. Any returned items *must* have prior authorization. Unauthorized returns are delayed in handling; these delays can be avoided by contacting Shure in advance and furnishing the necessary information.

If you are requested to return the equipment by Shure's Service Department, package the unit (with all information requested) as follows: Check to see that all parts are present and in place. If the original carton is not available, place the unit in a strong shipping carton at least 13 mm (6 in.) large in all three dimensions than the unit. Fill the surrounding space with a resilient packing material such as shredded paper, excelsior, Styrofoam, etc. Seal the carton with gummed paper tape, tie it with a strong cord, and ship it prepaid to the Shure Service Department.

It is extremely important that the packaged unit be well-packed and fully insured. Damage claims are subject to settlement between the shipper and the carrier, and this can delay repair and return of the unit.

Shure reserves the right to make design changes and product improvements without assuming any obligation to install these changes or improvements on any previously manufactured products. Shure also reserves the right to ship new and/or improved products which are similar to the form, fit and function of the originally ordered products.

---

**SHURE**<sup>®</sup>

*Breaking Sound Barriers*

---

---

222 HARTREY AVENUE, EVANSTON, ILLINOIS 60202-3696 U.S.A. • TELEPHONE: (312)866-2200 • CABLE: SHUREMICRO