

REAR VIEW OF MODEL M610

The Model M610 Feedback Controller is designed to improve sound reinforcement systems by allowing the user to smooth out major irregularities in the overall frequency response which tend to limit gain before feedback. Convenient inputs, outputs, and controls simplify installation and adjustment in either new or existing systems.

The Model M610-2E Feedback Controller is similar to the Model M610 except that it is designed to operate from either a 108-132 volt or 216-264 volt, 50/60 Hz power source as selected by a switch located on the rear panel.

Eight linear-motion potentiometers to allow gain reduction in each of eight octave frequency regions, high- and low-frequency roll-off switches, a filter level (volume) control, and a bypass/filter mode switch comprise the operating controls. Inputs and outputs for high- or low-impedance microphone lines and for auxiliary high-level lines are available.

**Features include:**

- Eight dip filters with depth individually adjustable from 0 to approximately 12 dB, centered at approximately 63, 125, 250, 500, 1000, 2000, 4000, and 8000 Hertz.
- Switches to insert 6 dB-per-octave roll-offs outside the frequencies covered by the dip filters.
- Unity gain in bypass mode for convenient installation in microphone or auxiliary lines.
- Filter level control, disabled in bypass mode, allows convenient increase of system gain as filters are adjusted.
- Female (input) and male (output) professional three-pin audio connectors, switchable for low- or high-impedance microphones.
- Phono pin jack, switch type, for auxiliary input. When a plug is inserted in auxiliary input the microphone input is automatically disabled.
- Phono pin jack for auxiliary output, usable simultaneously with microphone output.
- Low hum, noise, and RF susceptibility.
- Listing by Underwriters' Laboratories, Inc. and listing by Canadian Standards Association as certified. (M610 only)
- Jacks for external dc supply.

**SPECIFICATIONS**

**Test Conditions (Unless otherwise stated):**  
 Operating voltage of 120 Vac, 60 Hz.  
 Lo-Imp. Mic. Input through 150 ohms.  
 Hi-Imp. Mic. Input through 33K ohms.  
 Aux. Input through 10K ohms.

Lo-Imp. Mic. Output terminated in 150 ohms.  
 Hi-Imp. Mic. Output terminated in 33K ohms.  
 Aux. Output terminated in 47K ohms.  
 Below 63 and Above 8K switches set to flat position (up).  
 Filter Frequency linear potentiometers set to zero (Fully up).

**Gain:** Frequency, 1000 Hz.

**Bypass Mode:**

Output	Input		
	Lo-Imp. Mic.	Hi-Imp. Mic.	Aux.
Lo-Imp. Mic.	- 0.5 dB	-24.0 dB	-48.0 dB
Hi-Imp. Mic.	+24.0 dB	+ 0.5 dB	-23.5 dB
Aux.	+47.0 dB	+23.5 dB	- 0.5 dB

**Filter Mode (Filter Level control maximum):**

Output	Input		
	Lo-Imp. Mic.	Hi-Imp. Mic.	Aux.
Lo-Imp. Mic.	+24.5 dB	+ 1.0 dB	-23.0 dB
Hi-Imp. Mic.	+49.0 dB	+25.5 dB	+ 1.5 dB
Aux.	+72.0 dB	+48.5 dB	+24.5 dB

**Frequency Response (Bypass Mode or Filter Mode, no filters activated):**

Flat  $\pm 2$  dB, 40 Hz to 20 kHz.

**Hum and Noise, Maximum:**

Equivalent Input Hum and Noise, Lo-Imp. Mic., 150 ohm source, 20-20 kHz: 123 dB below 1 volt.  
 Equivalent Input Noise, Lo-Imp. Mic., 150 ohm source, 300-20 kHz: 125 dB below 1 volt.  
 Aux. Output Hum and Noise, 20-20 kHz: 71 dB below 1 volt.  
 Aux. Output Noise, 300-20 kHz: 73 dB below 1 volt.

**Aux. Output Clipping Level, Minimum:** 5 volts.

**Input Clipping Levels, Minimum:**

Lo-Imp. Mic.: 30 mV  
 Hi-Imp. Mic.: 450 mV

**Total Harmonic Distortion:**

0.5% Maximum THD at 1 kHz, at Aux. Output level of 1 volt in Bypass or Filter Mode with Filter Level control full up.

**Impedances:**

Input	Designed for Use With	Actual Impedance
Lo-Imp. Mic.	25- to 600-ohm Microphones	900 ohms
Hi-Imp. Mic.	33K ohm Microphones	200K ohms
Aux.	100-ohm to 10K ohm High Level Source	50K ohms

Output	Designed for Use With	Actual Impedance
Lo-Imp. Mic.	25- to 600-ohm Microphone Circuits	60 ohms
Hi-Imp. Mic.	33K ohm Microphone Circuits	5K ohms
Aux.	High Impedance (10K ohms or greater) Unbalanced Aux. Circuits	1K ohms

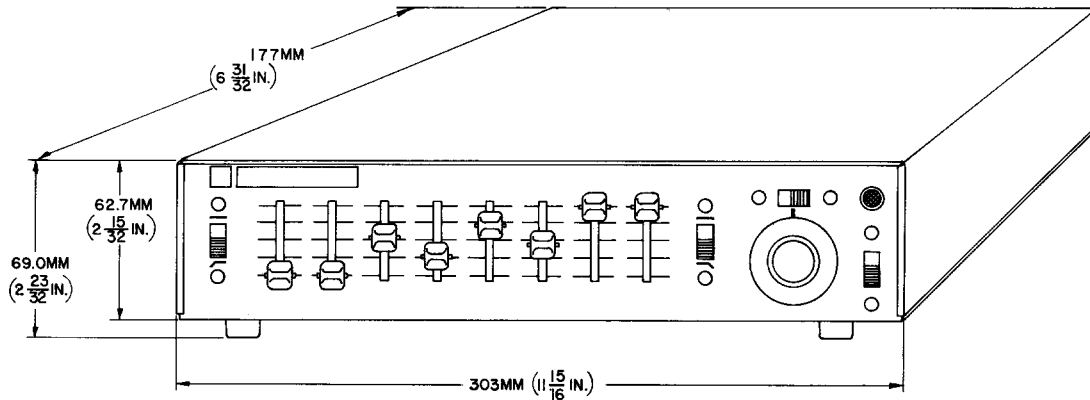

**OVERALL DIMENSIONS - FIGURE 1**

**Phase:**

Pin 3 of the Microphone Input is in phase with pin 3 of the Microphone Output and out of phase with the tip of Aux. Output and the tip of the Aux. Input.

**Filter Characteristics:**

Moving Filter Frequency control from 0 to 12 reduces gain by 12 dB  $\pm$  2 dB at frequency of maximum attenuation. This center frequency is within  $\pm$  20% of nominal frequency. One octave from center frequency, moving Filter Frequency control from 0 to 12 reduces gain by 3.5 dB  $\pm$  1 dB.

Below 63 switch: 6 dB per octave slope, 9 dB down ( $\pm$  2 dB) at 20 Hz.

Above 8K switch: 6 dB per octave slope, 8 dB down ( $\pm$  2 dB) at 20 kHz.

Typical filter frequency response characteristics are shown in Figures 4 and 5. Filters are electrically isolated for minimum phase interaction.

**Operating Voltage:**

AC Operation:

M610: 108-132 volts, 50/60 Hz, 3 watts

M610-2E: 108-132 volts or 216-264 volts, 50/60 Hz, 3 watts, as selected by a switch on the rear panel.

DC Operation: 30 volts  $\pm$  20% at approximately 12 mA.

**Temperature Range:**

Operating:  $-7^{\circ}\text{C}$  to  $57^{\circ}\text{C}$  ( $20^{\circ}\text{F}$  to  $135^{\circ}\text{F}$ )

Storage:  $-29^{\circ}\text{C}$  to  $71^{\circ}\text{C}$  ( $-20^{\circ}\text{F}$  to  $160^{\circ}\text{F}$ )

**Net Weight:** 1.8 kg (3 lb, 15 oz)

**Packaged Weight:** 2.4 kg (5 lb, 4 oz)

**Dimensions:**

See Figure 1.

**INSTALLATION**

**WARNING**

To reduce the risk of fire or electric shock, do not expose this appliance to rain or extreme moisture.

The M610 or M610-2E is typically connected in the auxiliary, high-level line between the preamplifier/mixer and the power amplifier, or between the microphone and the preamplifier/mixer in single-microphone systems. Any combination of inputs and outputs available may be used, however, according to the particular needs of the user.

The Model M610-2E is supplied with a three-conductor power-line cord, but no plug. The power-line cord plug should be installed by qualified service personnel. The brown lead should be connected to

the "live" or "hot" terminal of the plug, and the blue lead to the neutral terminal of the plug. The green/yellow lead is the grounding conductor and should be connected to the ground or earth terminal of the plug.

Before connecting the M610-2E to the power source, the line voltage selector slide switch on the rear panel (Item 22 of Figure 3) must be set to the proper position. To change the selector switch to the 108-132 V.A.C. position, loosen the mounting screw holding the switch locking tab until the tab can be rotated away from the switch lever. Tighten the mounting screw and set the switch as desired.

**CONTROLS AND CONNECTORS**

See Figure 3.

**Inputs:**

**Microphone:**

The microphone input (16), located on the rear panel and designated Mic. Input, is designed for low-impedance (balanced or unbalanced) microphones with 25 to 600 ohms impedance or high-impedance (unbalanced) dynamic, ribbon, or condenser microphones. The unit is not recommended for use with crystal or ceramic microphones. The impedance is selected by a slide switch (17) above the Mic. Input receptacle. The input receptacle is a professional three-pin audio connector (female).\* Figure 2 refers to microphone connections. See Figure 2 for low- and high-impedance connections to receptacle.

Note: Some condenser microphones produce very high output signals which may overload the input. Use of an attenuator (such as the Shure A15A In-Line Microphone Attenuator) will improve this situation.

\*Designed to mate with Cannon XL series, Switchcraft A3 (Q.G.) series or equivalent connector. [Shure part 95A407 (male) or 95A548 (female).]

**Auxiliary:**

The Aux. Input phono pin jack (15) on the rear panel has a built-in switch that disables the Mic. Input preamplifier when a phono plug is inserted.

The Aux. Input will accept output from a high-impedance, high-level source, such as a mixer, audio console, tape recorder, AM-FM tuner, or phonograph preamplifier.

**Outputs:**

The receptacle marked Mic. Output (18) is a dual-impedance output, either low impedance balanced or high-impedance unbalanced, as selected by the switch (19) above the receptacle. The receptacle is a professional three-pin audio connector (male).\* See Figure 2 for output receptacle connections.

The phono pin jack marked Aux. Output (20) is a high-impedance, high-level output designed primarily to feed

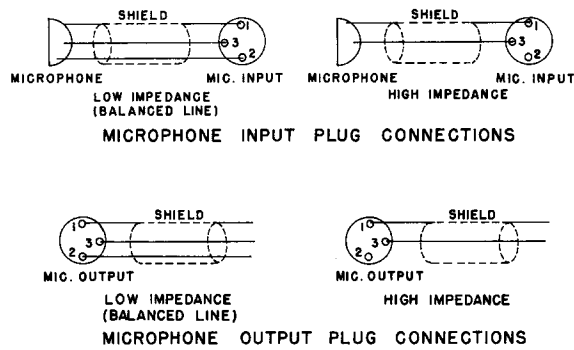

MICROPHONE CONNECTIONS - FIGURE 2

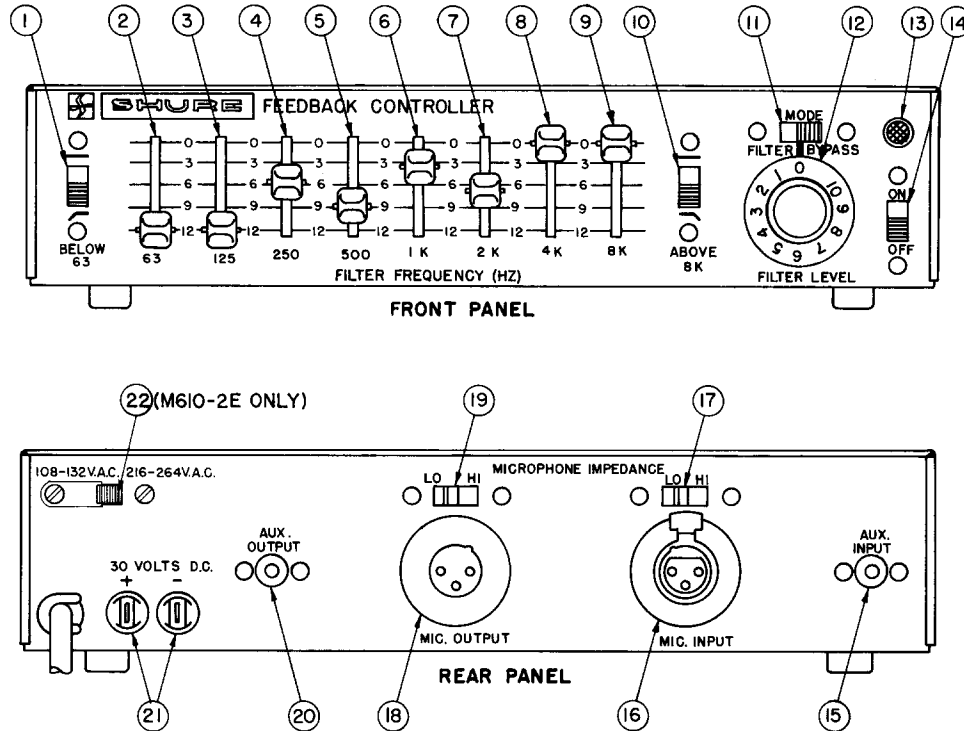

CONTROLS AND CONNECTORS - FIGURE 3

a power amplifier or auxiliary input requiring 0.1 to 2 volts.

**Accessory 30 Volts D.C.:**

These rear panel jacks (21) provide 30 volts dc for accessories such as the A68M Microphone Preampfier. The jacks are also used as a power input when using the Model A67B Battery Power Supply (Accessory). These jacks provide 34 Vdc open circuit (30 Vdc at 6 mA max.).

**Controls (See Figure 3):**

**Power Switch and Pilot Light:**

The power On-Off switch (14) controls the operation of the unit when it is powered either by the ac line or by an external dc source. The pilot light (13) indicates operation only when ac power is used.

**Filter Frequency Controls:**

The eight linear motion Filter Frequency controls (2)-(9) located on the front panel are used for adjusting the level of eight octave-spaced bands having center frequencies of 63 Hz, 125 Hz, 250 Hz, 500 Hz, 1 kHz, 2 kHz, 4 kHz, and 8 kHz respectively. The levels of the octave-spaced bands are individually and continuously adjustable from flat at full up position to approximately 12 dB

cut at full down position. Figures 4-1 and 4-2 illustrate the frequency response characteristic of each octave filter when adjusted for 6 dB cut and full cut.

**Below 63 and Above 8K Switches:**

The Below 63 filter slide switch (1) reduces the gain of frequencies below the 63 Hz octave band when placed in the down position, and the Above 8K filter slide switch (10) reduces the gain of frequencies above the 8 kHz octave band when placed in the down position. Figure 5 shows the frequency response characteristics of these filters.

**Mode (Filter-Bypass) Switch:**

In the Bypass position, the Mode switch (11) disables the filters and the Filter Level control and sets gain from Aux. Input to Aux. Output or Mic. Input to Mic. Output, at approximately unity. The filters and Filter Level control are operative in the Filter position.

**Filter Level Control:**

The Filter Level control (12) provides up to 24 dB gain when filters are enabled, as well as gain reduction below unity. The Filter Level control is used to increase system gain as filters are adjusted. A setting of 4 for this control will provide approximately unity gain through the Controller in the Filter mode.

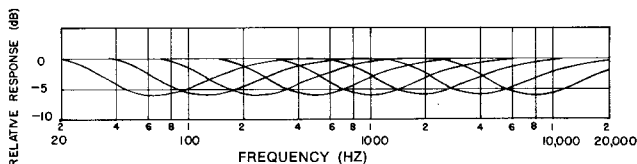

FIGURE 4-1 — EACH FILTER AT 6 dB ATTENUATION

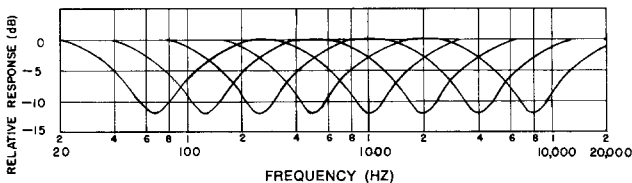

FIGURE 4-2 — EACH FILTER AT MAXIMUM ATTENUATION

**INDIVIDUAL OCTAVE FILTER FREQUENCY CHARACTERISTIC (TYPICAL)**

**FIGURE 4**

**OPERATION**

1. Connect line cord to ac power source or use A67B Battery Power Supply.  
Set panel controls as follows:  
On-Off slide switch (14) to ON position.  
Mode slide switch (11) to BYPASS position.  
Below 63 (1) and Above 8K (10) slide switch to flat (up) position.  
All eight Filter Frequency controls (2)-(9) to full up position.  
Filter Level control (12) to zero (fully counterclockwise).
2. Adjust the amplifier gain of the sound system (using the preamplifier/mixer or power amplifier volume control) until feedback becomes apparent. Reduce the gain setting until it is comfortably below the feedback level.
3. Set Mode slide switch (11) to FILTER position. Increase Filter Level control (12) until feedback squeal or ringing is heard.
4. If the feedback sound is high pitched, one of the four high-frequency Filter Frequency controls (1 kHz through 8 kHz) (6)-(9) will be most effective in eliminating the feedback. Individually move each Filter Frequency control slowly from top to bottom and back to top while listening for feedback. The control which eliminates feedback with the least motion should then be moved down only so far as necessary to eliminate the feedback.
5. If the feedback frequency happens to fall between the bands covered by two adjacent controls, then it may be necessary to move down both controls to obtain the desired feedback suppression.
6. If the feedback sound first noted in step 4 is of a low frequency, then the adjustment procedure should be started using the low-frequency (63 Hz through 500 Hz) Filter Frequency controls (2)-(5).
7. Having eliminated the first feedback condition, increase the gain of the sound system with the Filter Level control (12) until feedback is again noted. Repeat the procedures of the preceding steps 3 through 6 to eliminate the new feedback condition. This may require adjustment of a different Filter Frequency control or may require a further decrease in the control or controls previously moved down.

8. Repeat step 7 until either (A), one or more Filter Frequency controls has been set to maximum attenuation, or (B), feedback appears to occur at more than one frequency simultaneously. Do not reduce the setting of any Filter Frequency controls more than necessary to stop ringing or squealing during the above procedure.
9. Conduct a talk test through the sound system with the Mode switch set to FILTER and listen for ringing. If ringing is noted, attempt to eliminate it by a slight decrease in the setting of the Filter Level control or further decrease in the appropriate Filter Frequency control setting.
10. During the above procedure, it will not usually be necessary to set either the Below 63 or Above 8K switches to the down position to eliminate feedback unless the pitch of the feedback is extremely low or extremely high. These switches are primarily intended for improving overall sound quality or tonal balance, if necessary. After feedback has been eliminated as outlined above, actuate each switch and note the tonal character of the system during the talk test. It will usually be advantageous to actuate the Below 63 switch if the 63 Hz Filter Frequency control is set below 6, and to actuate the Above 8K switch if the 8 kHz Filter Frequency control is set below 6.

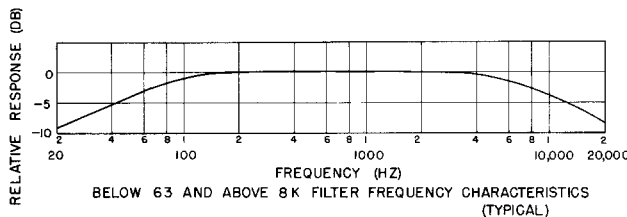

**FIGURE 5**

**WARNING**

Voltages in this equipment are hazardous to life.  
Refer servicing to qualified service personnel.

**OPTIONAL ACCESSORIES**

- Locking Panel ..... Model A68L
- Rack Panel Kit ..... Model A68R

**GUARANTEE**

This Shure product is guaranteed in normal use to be free from electrical and mechanical defects for a period of one year from date of purchase. Please retain proof of purchase date. This guarantee includes all parts and labor. This guarantee is in lieu of any and all other guarantees or warranties, express or implied, and there shall be no recovery for any consequential or incidental damages.

**SHIPPING INSTRUCTIONS**

Carefully repack the unit and return it prepaid to:  
Shure Brothers Incorporated  
Attention: Service Department  
1501 West Shure Drive  
Arlington Heights, Illinois 60004

If outside the United States, return the unit to your dealer or Authorized Shure Service Center for repair. The unit will be returned to you prepaid.



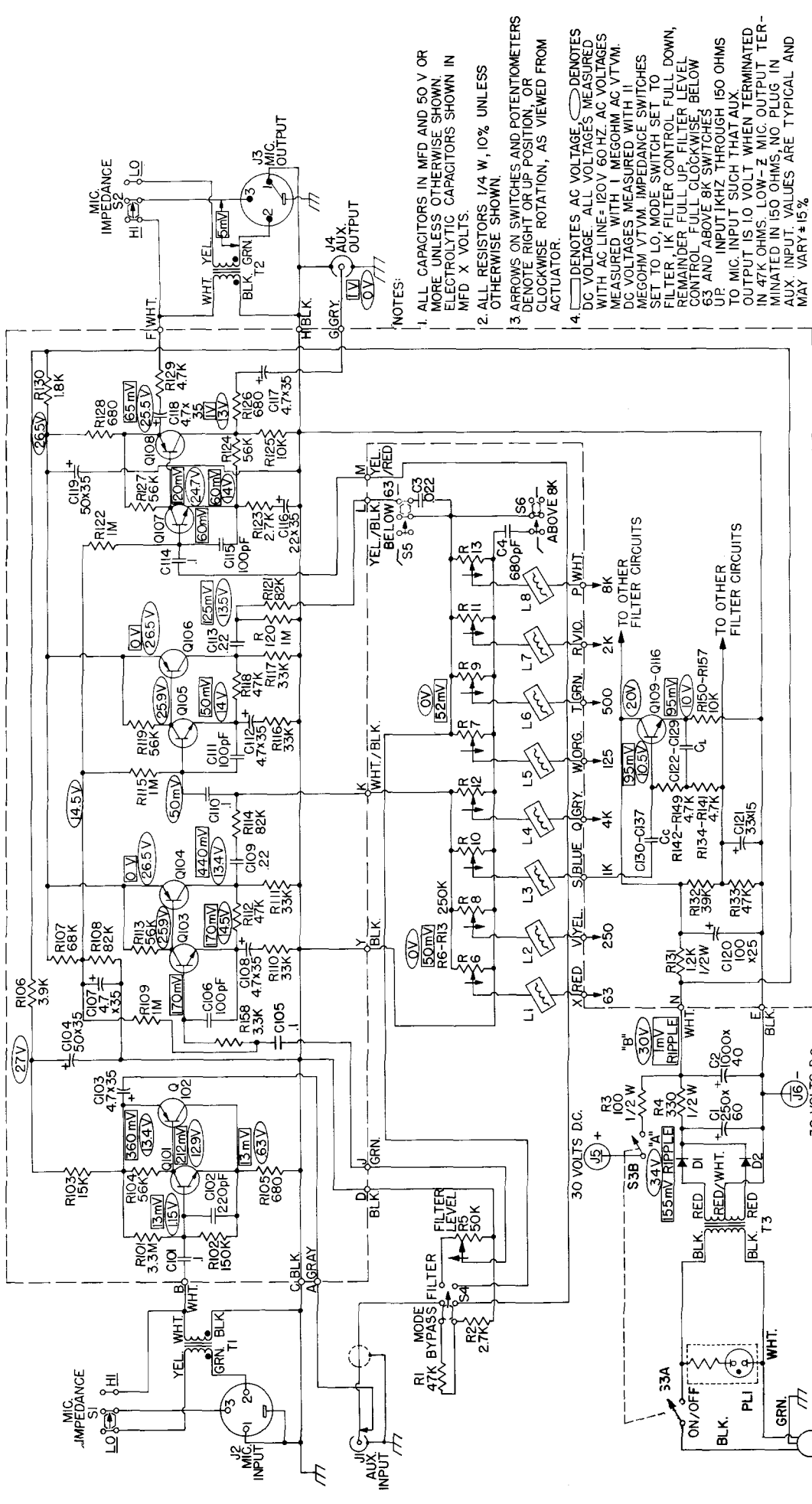

- NOTES:
1. ALL CAPACITORS IN MFD AND 50 V OR MORE UNLESS OTHERWISE SHOWN. ELECTROLYTIC CAPACITORS SHOWN IN MFD X VOLTS.
  2. ALL RESISTORS 1/4 W, 10% UNLESS OTHERWISE SHOWN.
  3. ARROWS ON SWITCHES AND POTENTIOMETERS DENOTE RIGHT OR UP POSITION, OR CLOCKWISE ROTATION, AS VIEWED FROM ACTUATOR.
  4. DENOTES AC VOLTAGE. DENOTES DC VOLTAGE. ALL VOLTAGES MEASURED WITH AC LINE = 120V 60 HZ AC VOLTAGES MEASURED WITH 1 MEGOHM AC VTVM. DC VOLTAGES MEASURED WITH 11 MEGOHM VTVM IMPEDANCE SWITCHES SET TO LO. MODE SWITCH SET TO FILTER, 1K FILTER CONTROL FULL DOWN, REMAINDER FULL UP. FILTER LEVEL CONTROL FULL CLOCKWISE, BELOW 63 AND ABOVE 8K SWITCHES, BELOW TO MIC. INPUT SUCH THAT AUX. OUTPUT IS 10 VOLT WHEN TERMINATED IN 47K OHMS, LOW-Z MIC. OUTPUT TERMINATED IN 150 OHMS, NO. PLUG IN AUX. INPUT. VALUES ARE TYPICAL AND MAY VARY ±15%.
  5. VALUES OF C122-C137 SHOWN IN FOLLOWING TABLE. ALL VALUES IN MFD UNLESS OTHERWISE INDICATED.

Fo	Cl	Cg	Fo	Cl	Cg
63	3.3 (C122)	0.82 (C130)	1K	18 (C126)	0.056 (C134)
125	1.5 (C123)	0.47 (C131)	2K	1 (C127)	0.027 (C135)
250	0.82 (C124)	0.22 (C132)	4K	0.47 (C128)	0.015 (C136)
500	0.39 (C125)	0.12 (C133)	8K	0.27 (C129)	0.008 (C137)

MODELS M610 AND M610-2E  
 FEEDBACK CONTROLLER CIRCUIT DIAGRAM

30 VOLTS D.C.  
 30V RIPPLE  
 30 VOLTS D.C.

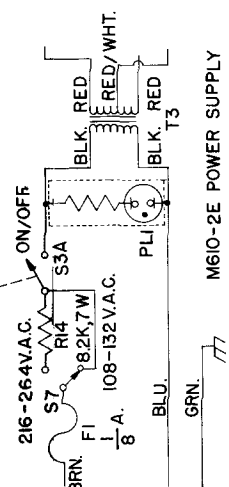

M610 POWER SUPPLY  
 M610-2E POWER SUPPLY