

# SHURE®

Shure Brothers Incorporated  
222 Hartrey Avenue  
Evanston IL 60202-3696 U.S.A.

## Model DFR11EQ Version 4 User Guide

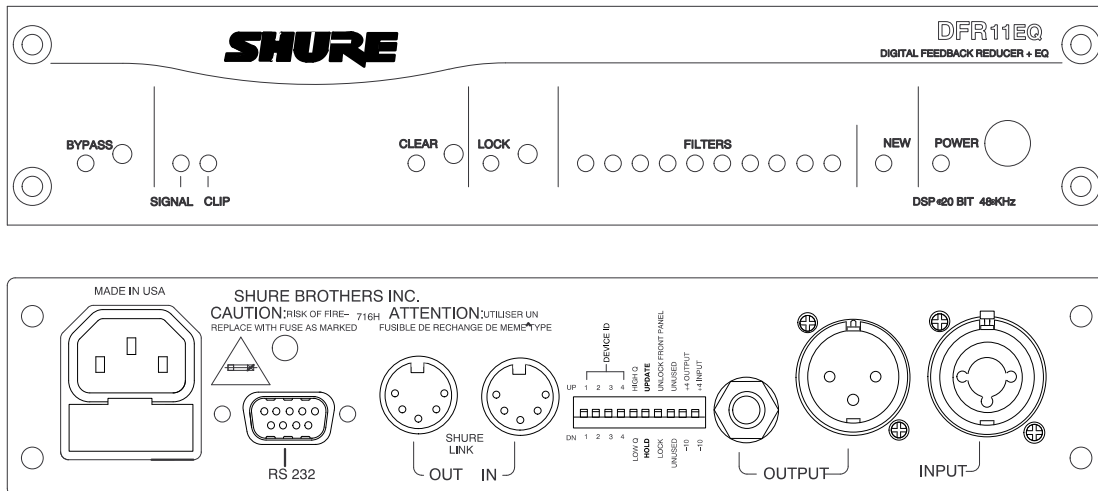

# DFR11EQ

**Digital Feedback Reducer  
with Windows\* Software Version 4 for Equalizer and Delay**

**Réducteur de Larsen numérique  
avec logiciel Windows\* version 4 pour égaliseur et délai**

**Digitale Rückkopplungsreduzier-Stufe  
mit Windows\* Softwareversion 4 für Equalizer und Delay**

**Reductor digital de realimentación y ecualizador gráfico  
con software Versión 4 compatible con Windows\*  
para ecualizador y retardo**

**Attenuatore di retroazione digitale  
con software Windows\*, versione 4, per equalizzatore  
e ritardo**

---



---

# TABLE OF CONTENTS

- WHAT'S NEW IN VERSION 4 SOFTWARE** ..... 2
- INTRODUCTION** ..... 3
  - Features ..... 3
  - Added Features When Interfaced with a Personal Computer ..... 3
- THE DFR11EQ** ..... 4
  - Overview ..... 4
  - DFR11EQ Theory ..... 6
  - Setup for Feedback Control ..... 8
  - Audio Connections ..... 10
- VERSION 4 SOFTWARE** ..... 12
  - Introduction ..... 12
  - Overview ..... 15
- FEEDBACK REDUCER** ..... 16
- EQUALIZER** ..... 19
  - Graphic Equalizer ..... 19
  - Parametric Equalizer ..... 22
- DELAY** ..... 25
- OUTPUT CONTROLS** ..... 28
  - IN/OUT Meters and Output Control ..... 28
  - Reversing the Signal Polarity ..... 28
- RESPONSE GRAPH** ..... 29
  - Response Curves ..... 29
  - Snapshots ..... 30
- SHURE LINK NETWORKS** ..... 31
- MAINTENANCE** ..... 32
  - Scenes ..... 32
  - Customizing Graph Colors ..... 33
  - Exiting the DFR11EQ Application ..... 33
  - Printing DFR11EQ Settings ..... 34
- APPENDIX A. SPECIFICATIONS** ..... 35
- APPENDIX B. RACK MOUNTING THE DFR11EQ** ..... 37
- APPENDIX C. CONNECTORS AND CABLES** ..... 38
- APPENDIX D. KEYBOARD CONTROLS** ..... 42

**Trademark Notifications:** Shure is a registered trademark of Shure Brothers, Inc. Windows is a registered trademark of Microsoft Corporation. Crystal is a trademark of Crystal Semiconductor Corporation. Motorola is a registered trademark of Motorola, Inc. IBM is a registered trademark of the IBM Corporation.

---

## WHAT'S NEW IN VERSION 4 SOFTWARE...

---

**Software Version 4 for the DFR11EQ offers the same features as before, plus much more...**

**Switchable Graphic or Parametric Equalization...** Now, you can set the equalizer to work as a graphic equalizer or as a parametric equalizer. This flexibility can help meet your needs as different situations arise. Use the graphic equalizer to equalize overall room sound; or use the parametric equalizer to control the major feedback frequencies covered by the feedback filters, so you can free up all the feedback filters to act as dynamic filters for stray feedback.

**Editable Digital Feedback Filters...** You can edit the frequency, depth, and width of individual feedback filters, so the feedback filters can be utilized as additional parametric filters.

**Digital Delay...** For use in larger sound systems which utilize widely spaced loudspeakers, such as in fill systems. The delay can improve the audio quality of a sound system by delaying the audio signal to the remote loudspeaker until it is in alignment with the sound waves coming from other loudspeakers in front. Phase cancellation and sound localization problems are minimized.

**More Scenes...** Unlike the Version 3 software, which is limited to 16 scenes stored in the DFR11EQ.INI file on the computer, the Version 4 software can store any number of scenes each in separate files. There is now a field for entering descriptions of scenes which appears in the Recall Scene function, so you can find the desired scene before loading.

**Hold Mode Automatically Restores the Basic Feedback Filter Setup...** Once you ring out a room, just flip the Update/Hold DIP switch to the Hold position. In Hold mode, a DFR11EQ may change Dynamic filters or deepen Fixed filters, but the original settings will be restored the next time you power up the unit. This is useful for storing the best filter settings for a given system — that system can then be set in Update mode for a different program, then returned to Hold mode to restore the usual settings.

**Reverse the Output Signal Polarity...** If there is a piece of equipment in the sound system which inverts the polarity of the audio signal, use the Version 4 software to provide the correct signal polarity.

**DFR11EQ Setting Printouts...** These are useful for documenting a sound system. With this option, you can now printout a hardcopy which shows all of the settings for a selected DFR11EQ.

**Input and Output Level Meters and Output Control...** There are now input and output meters, so you can see the effect of the signal processing on the audio signal. You can check these meters to see if the equalized output sound levels are getting too low compared to the unaffected input levels. There is now a output control you can use to raise the output level to compensate. The frequency response curve graph will adjust with the output level slider, showing you the current operating level.

**Undo...** It is now possible to undo the most immediate filter deletions.

**Response Graph Snapshots...** When you take a snapshot, the computer stores the frequency response curve. As you make changes in the filters or equalization, you can show the snapshot to see the difference between the old response and the new.

**Advanced Shure Link Networking Options...** You can assign an individual name to each Device ID, to make it easier to remember the Devices in a system. The new networking menu identifies the Device ID, name, scene, modified status of that scene, and Device type.

**Window Hiding...** If you want to use the software but need to conserve space on the screen, you can now independently hide the Equalizer panel and the Response Graph panel. For instance, if you want to set the graphic equalizer, but have no current need to see the Response Graph, you can hide the Response Graph to leave room on the screen to view other applications you may be running.

**Backwards Upgradeability...** Using software Version 4, earlier DFR11EQs can be upgraded.

# INTRODUCTION

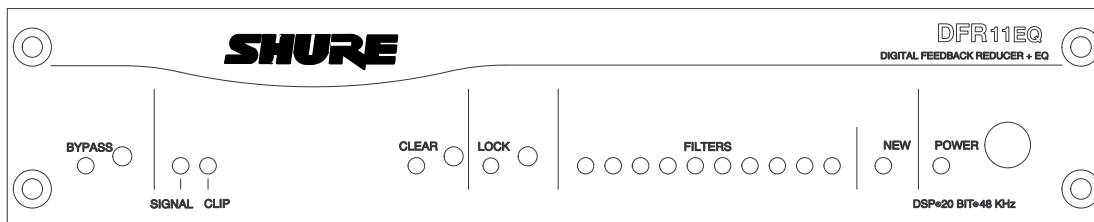

The Shure Model DFR11EQ is a single channel signal processor that combines a feedback reducer, equalizer, and delay in a single, half-rack enclosure. The DFR11EQ is designed to be placed in a sound reinforcement signal path to automatically detect and control acoustical feedback and equalize overall sound system response. The DFR11EQ is designed for installed sound reinforcement applications: theater, conference rooms, meeting halls, houses of worship, etc. The DFR11EQ is also an effective setup tool for controlling major feedback modes in live music applications.

The feedback reducer of the DFR11EQ automatically inserts narrow notch filters at detected feedback frequencies. These notch filters stop a sound system from feeding back, but are narrow enough so their effect on audio quality is minimized. The feedback detection algorithm constantly searches for feedback, with or without the presence of program audio. The feedback reducer functions on its own or under external computer control.

The equalizer of the DFR11EQ can be set to act as either a graphic or parametric equalizer.

## Hardware Features

- Adaptive Notch Filter algorithm (patent pending) which automatically detects feedback and deploys up to 10 narrow band notch filters.
- Crystal\* 20-bit A/D and D/A converters (Analog-to-Digital, Digital-to-Analog) for 104 dB dynamic range.
- 48 kHz sampling rate for flat response to 20 kHz.
- 1/2 rack space chassis allows rack mounting of one or two units in a single rack space with no sagging or bending.
- Shure Link Interface allows multiple units to be programmed with a single computer.
- No internal batteries. Settings and DSP program stored in internal EEPROM.
- Electronically balanced input with combination 1/4-in. and XLR connector. Can be used with balanced or unbalanced outputs.
- Independently driven, cross-coupled, balanced 1/4-in. and XLR outputs. Can be used with balanced or unbalanced inputs, without signal loss.
- +4 dBu/–10 dBV DIP-switch-selectable input and output levels.
- 80 MHz Motorola\* DSP56009 processor engine with full 24-bit internal processing.
- RS-232 interface for external computer control and firmware updates.
- Internal linear power supply switchable between 120 and 240 Vac eliminates the need for a cumbersome external power supply.
- Solid state bypass eliminates unreliable mechanical relays and switches.

## Software Features

- A tamper-proof equalizer which can be switched between 30-band graphic or 10-band parametric.
- The graphic equalizer is constant-Q, 30-band, 1/3-octave graphic equalizer. Can boost up to 6 dB or cut 12 dB for each band.
- The parametric equalizer offers 10 filters with adjustable frequency, up to 6 dB of boost or –18 dB of cut, and up to a two octave bandwidth.
- Up to 100 ms Digital Delay.
- Front/back panel lockout control.
- Response Curve Viewing. Displays frequency response of the feedback reducer, equalizer, or both.
- Storage of multiple scenes to floppy or hard disk.

# THE DFR11EQ

## Overview

### Front Panel

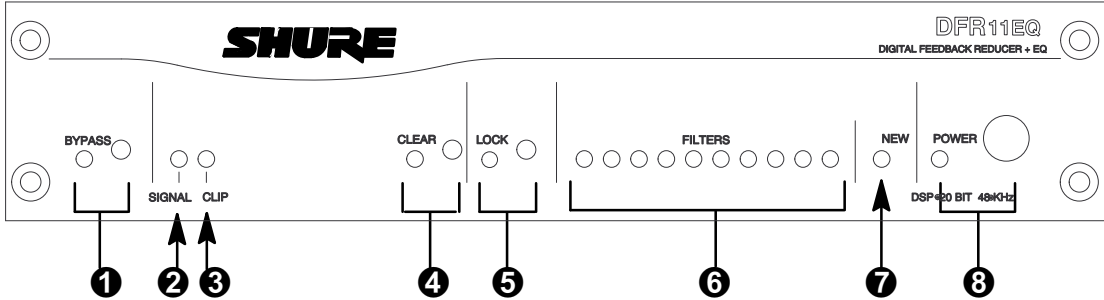

- 1 BYPASS Button and LED.** Press this button to suspend feedback reducer operation and remove filters from the audio path. Does not affect the graphic equalizer. When the LED illuminates, the feedback reducer is bypassed.
- 2 SIGNAL LED.** Illuminates when input signal is present. Intensity varies with input signal level.
- 3 CLIP LED.** Illuminates when the input signal is within 6 dB of clipping.
- 4 CLEAR Filters Button and LED.** Press this recessed button to reset all the feedback filters. Clears filters even if Lock Filters is enabled. LED illuminates as the button is pressed.
- 5 LOCK Filters Button and LED.** Press this button to lock the filters at their current values. When the LED is on, the unit will not change or add any feedback filters.
- 6 FILTERS LEDs (10).** Indicate when individual feedback filters are active. When a filter changes or is added, the LED flashes, then stays on.
- 7 NEW LED.** Flashes in unison with the feedback filter LEDs when the detector is deploying a new feedback filter or changing an existing one. Also flickers whenever the unit is receiving commands from a connected computer.
- 8 POWER Switch and LED.** Press this button to turn the power on. LED illuminates when unit is powered on. When the power is off, the unit is bypassed automatically.

### Back Panel

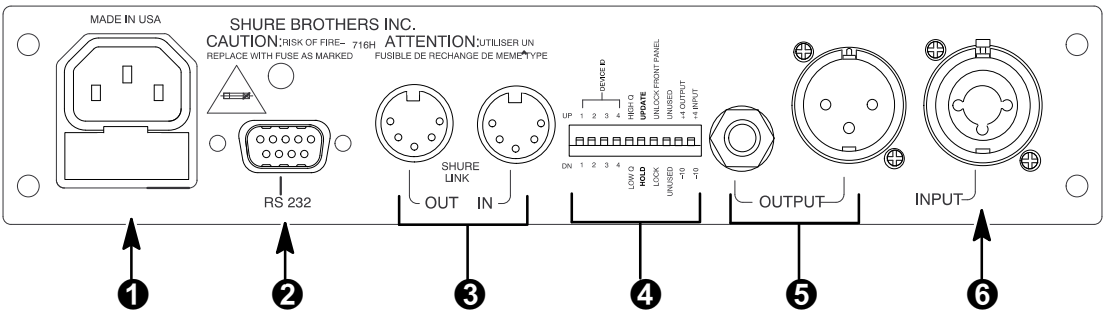

- 1 Power Connector with Integral Fuse.** Connects to AC power. The fuse is located in the drawer below the connector.
- 2 9-Pin RS-232 Port.** Connects the unit to a computer. For use with DFR11EQ software and for DSP firmware upgrades.
- 3 Shure Link Interface.** Allows linking of up to 16 DFR11EQs which may be accessed by computer.
- 4 DIP Switches.** See *DIP Switches*.
- 5 Output Connector— $1/4$ -Inch & XLR.** Active, cross-coupled, balanced outputs can be used with balanced or unbalanced inputs. Can be switched between +4 dBu/–10 dBV line-level operation by DIP switch.  $1/4$ -Inch and XLR are driven independently and either can be balanced or unbalanced without affecting the other.
- 6 Input Connector—Combined XLR and  $1/4$ -Inch.** Active balanced input can be used with balanced or unbalanced outputs. Can be switched between +4 dBu/–10 dBV line-level operation by DIP switch.

## DIP Switches

The DIP switches located on the rear panel are used for adapting the unit to the sound system requirements. Switches 5 through 10 change other available options, see the table below.

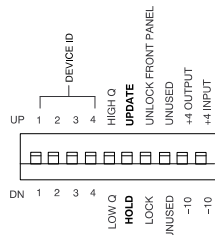

DIP SWITCH	FUNCTION	POSITION	
		UP	DOWN
1–4	Device ID	see below	see below
5	<b>Feedback Filter Bandwidth Select</b> Determines the Q of the feedback filter.	High Q 1/10-octave Feedback Filters remain narrow as they deepen	Low Q 1/10-octave Feedback Filters widen as they deepen
6	<b>Feedback Filter Memory Mode</b>	Update Stores changed feedback filter settings on power down	Hold Discards changed feedback filter settings on power down, but holds original settings
7	<b>Front Panel Lockout</b> Disables the front panel controls, except the power switch. Protects current settings from tampering.	Unlock Front panel buttons operational	Lock Front panel buttons inactive
8	unused	—	—
9	<b>Output Sensitivity</b>	+4 dBu	-10 dBV
10	<b>Input Sensitivity</b>	+4 dBu	-10 dBV

## Shure Link Device ID

When multiple DFR11EQ's are linked, each one must be assigned a unique Device ID, 0 through 15. DIP switches 1 through 4 on the rear panel are used to set the Device ID. To change the Device ID, align the switches according to the illustrations below. The unit comes factory preset to Device ID 15.

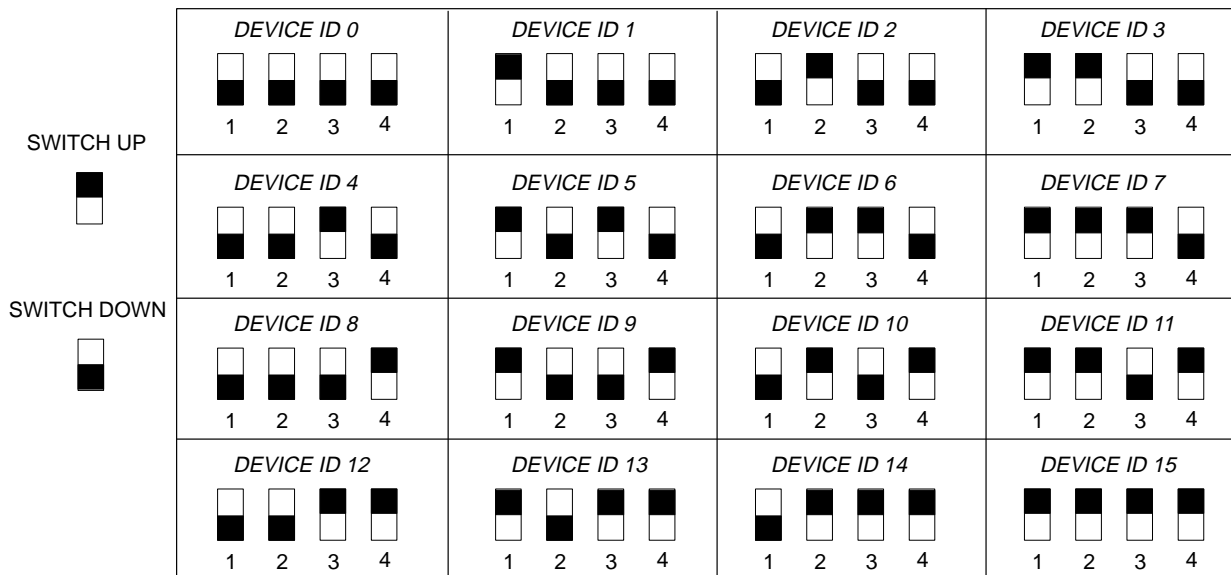

# DFR11EQ Theory

## Feedback and DFR11EQ Operation

When acoustical feedback occurs in a sound system, it is because the gain of the system is too high. Since no sound system (microphones, loudspeakers, room acoustics, etc.) has an absolutely flat frequency response, feedback will occur at specific frequencies before others; these are the frequencies with the most gain. If the gain at only these specific frequencies is lowered, then the system can operate with more overall gain before it feeds back, without a perceptible difference in tonal quality. This is the operating principle of the DFR11EQ.

At the heart of the DFR11EQ is a very powerful algorithm that can accurately and quickly discriminate between feedback and non-feedback sounds (speech and music). When this algorithm detects feedback, it smoothly inserts a -3 dB, 1/10-octave notch filter into the audio path to reduce the gain at the frequency which is feeding back. If the feedback does not stop, the filter depth is increased in 3 dB increments (up to -18 dB) until the feedback stops.

The illustrations below demonstrate how the DFR11EQ works in a sound system. The system on the left shows a feedback loop, where the microphone picks up off axis sound from the loudspeaker and sends it back into the sound system. The system on the right shows how the DFR11EQ, when installed in the sound system, senses that loop and filters out the excess gain on that frequency.

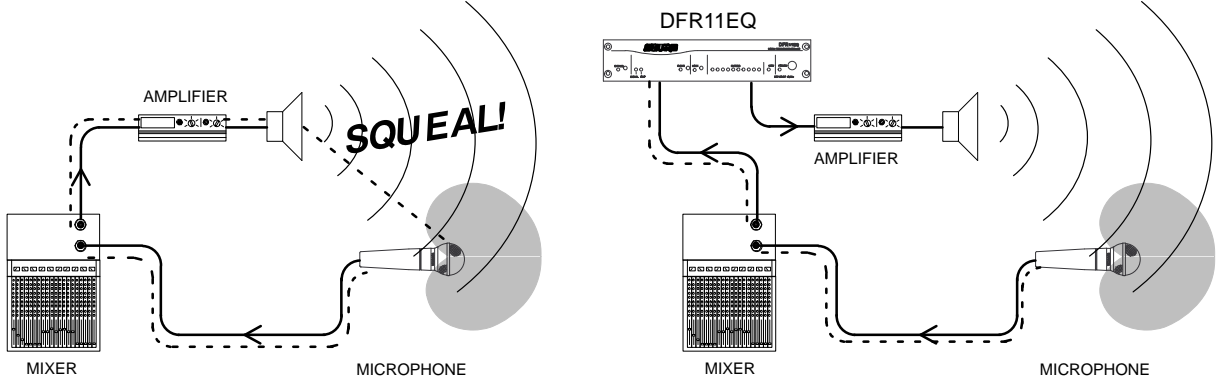

After the DFR11EQ stops the feedback at one frequency, the sound system may start feeding back at another frequency. In this case, the DFR11EQ inserts another notch filter into the audio path at the new frequency. The DFR11EQ can insert a total of 10 notch filters to reduce feedback.

## DFR11EQ Limitations

The DFR11EQ (or any other notch filter system) cannot entirely eliminate feedback in a sound system, it can only help to reduce it. In a typical system, a point of diminishing returns is reached after 4 to 8 notch filters are set. This is because generally there are only a few dominant frequency response peaks above the response of the entire system (see diagram below). The DFR11EQ works very well controlling these peaks. The user can expect a 6 to 9 dB improvement of gain-before-feedback in a typical system. However, if the system has too much overall gain, then all of the frequencies have too much gain; instead of trying to notch out all of the frequencies, better results will be obtained by lowering the gain of the system. If the system still has insufficient gain, then other changes must be made to the sound system such as different microphone or loudspeaker placement.

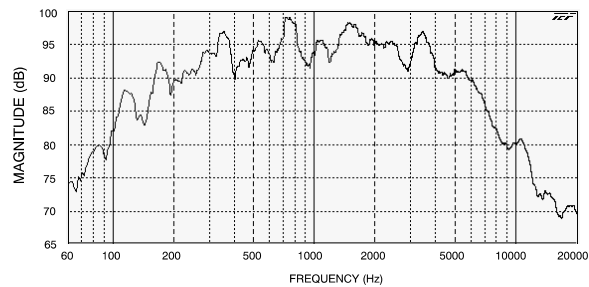

FREQUENCY RESPONSE OF AN UNEQUALIZED SOUND SYSTEM

## Fixed and Dynamic Notch Filters

The DFR11EQ can control the notch filters as either *dynamic* or *fixed*. The DFR11EQ's 10 notch filters are factory preset as 5 fixed and 5 dynamic filters. The first filters to be set are fixed, then the remaining filters are set as dynamic. After all 10 notch filters are set and a new feedback frequency is detected, the DFR11EQ will remove the oldest set dynamic filter and re-deploy it at the new feedback frequency. The fixed filters remain unchanged. However, if feedback occurs at the same frequency as an existing dynamic or fixed filter, the existing filter will deepen. The number of fixed versus dynamic filters can be adjusted via the DFR11EQ's Windows interface.

An example of a system that would benefit from more fixed filters and fewer dynamic filters is one that has fixed microphone and loudspeaker locations. In this type of system, the most dominant frequencies of feedback are defined by the room dimensions and the microphone and loudspeaker placement, and will not change appreciably. However, feedback can still occur, for instance, when someone's hand or head approaches a microphone. A good setting for this type of system would be 7 fixed filters for the non-changing feedback frequencies, and 3 dynamic filters to catch the feedback frequencies caused by the talker.

On the other hand, more dynamic than fixed filters would be appropriate in a system that has several non-stationary wireless microphones. Eight or even all 10 filters could be set to dynamic in this type of system to obtain maximum feedback protection. As every application is different, some experimentation is recommended to get the best results from a given sound system.

## High Q Filters vs. Low Q Filters

The DFR11EQ offers two selections for the shape of the  $1/10$ -octave notch filters. The first, High Q, is the default setting. A High Q filter's width stays very narrow as the filter depth is increased. This attenuates the minimum amount of signal possible to ensure system stability, while maintaining excellent sound quality. This setting is appropriate for most applications.

The Low Q setting maintains the filter's shape as it is deepened, so the width of the filter effectively widens as the depth increases. Using this setting attenuates the signal more, producing a greater system stability than the High Q setting, but with slightly diminished sound quality. This setting is appropriate for systems such as a speech-only PA where stability is an absolute must, but the sound quality can be compromised a bit.

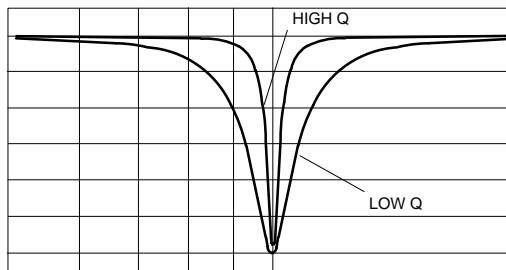

## Filter Locking

The feedback filters can be locked from the front panel of the unit or from the computer interface. When locked, new filters will not be deployed and existing filters will not be deepened, even if feedback is detected. The DFR11EQ's algorithm is designed to accurately differentiate feedback from non-feedback sounds such as speech. However, certain sounds which sound like feedback, such as high notes on a piano or synthesizer, may cause the algorithm to deploy an unwanted filter. You may want to lock the feedback filters during a musical performance for artistic reasons—many guitar players like to play with feedback as part of their sound, so locking the filters keeps them from removing any desired feedback.

For most applications, locking the feedback filters is unnecessary. As a rule of thumb, if the application will contain material which sounds similar to acoustic feedback, then it is prudent to lock the filters after ringing out the sound system.



## Setup for Feedback Control

The DFR11EQ will operate stand-alone as a feedback reducer. However, when connected to a personal computer running the supplied DFR11EQ software, additional options are available. See *Computer Interface* for details.

There are two basic ways in which to set-up the DFR11EQ: The “Ring Out” method and the “Insurance Policy” method. Each is valid for different situations. The “Ring Out” method is a preemptive measure in which the system gain is raised beyond the normal setting to deliberately make the system feed back. The DFR11EQ will then set its filters, and the system gain is then reduced slightly, and the system is stable and useable. This set-up method is primarily used for systems which are operated near the feedback point and need an extra margin of stability.

For the “Insurance Policy” method, the DFR11EQ is simply installed in the sound system, but filters are not set prior to use. The DFR11EQ adds extra insurance against feedback: the system is not expected to feed back, but if it does, the DFR11EQ is there to catch it. This set-up method is used for systems which already have sufficient gain-before-feedback, but need protection from the occasional stray feedback which can occur due to non-stationary microphones or user-adjustable gain controls.

### Setup

1. Connect the DFR11EQ in the desired signal path location. See *Audio Connections*.
2. Set the input and output level DIP switches to the appropriate settings for the sensitivities of the connected equipment.

**WARNING:** Other equipment may potentially be damaged after DFR11EQ power off if the DFR11EQ input is set to +4 and the output is set to -10. It is recommended that you avoid using this setting.

3. Set the system gain to minimum, and power up all of the equipment.
4. Slowly raise the gain of the system, and set the gain of each microphone to achieve the desired level.
5. The red CLIP LED should illuminate only on the highest signal peaks. If it illuminates more frequently, check to see that the input level switch is set properly. If it is, lower the level of the signal going into the DFR11EQ.
6. At this point it is highly recommended to equalize the sound system with the DFR11EQ's built-in equalizer (see *Computer Interface*) or an external equalizer. The DFR11EQ's feedback reducer is more effective on a well-equalized sound system.

### Ringing Out the System (“Ring Out” method only)

1. If necessary, clear any notch filters in the DFR11EQ by pressing the CLEAR button. Turn off the BYPASS and LOCK LEDs if they are not already off.
2. Slowly raise the gain of the signal going through the DFR11EQ. When feedback occurs, the DFR11EQ will insert a filter deep enough to stop the feedback.
3. Repeat step 2 until all fixed filters are set. (There are 5 fixed filters, unless changed by the user via the computer interface.)
4. Lower the gain by 3 to 6 dB to stabilize the sound system.

## Hold/Update

**UPDATE position...** When the HOLD/UPDATE DIP switch is in the UPDATE position (default), the DFR11EQ saves the feedback filters every time the unit is powered off. When the DFR11EQ is powered on again, the feedback filters will be at exactly the same settings as when the unit was powered down.

**HOLD position...** When the HOLD/UPDATE DIP switch is changed to the HOLD position, the DFR11EQ immediately saves the feedback filters at the current settings. When the DFR11EQ is powered off, any changes made to the feedback filters after the switch was set will be forgotten. When powered on again, the feedback filter settings will be exactly the same as when the HOLD/UPDATE DIP switch was changed to the HOLD position. This feature is useful for storing the best filter settings for a sound system.

To store filter settings in the HOLD memory:

1. Set the Hold/Update DIP switch to the Update position;
2. Ring out the room until all fixed filters are set;
3. Set the Hold/Update DIP switch to the Hold position;
4. During the performance, the DFR11EQ will change dynamic filters and deepen fixed ones;
5. After the performance, turn the power off and back on; the DFR filters are restored to the state they were in before the performance.

# Audio Connections

The DFR11EQ should be placed where an equalizer would be in a signal path — it should be one of the final pieces of equipment a sound signal passes through before going to a power amplifier. Other signal processors (for example, delay or reverb effects devices) should be placed before the DFR11EQ along the signal path. However, dynamics processors such as compressor/limiters should be placed after the DFR11EQ.

The following four diagrams show typical connections. Because of its utility and flexibility, the DFR11EQ can be connected in a large variety of different setups to benefit a sound system.

**NOTE:** See Appendix C. for descriptions of all cable and connection wiring.

## Between the Mixer Main Output and the Power Amplifier

The DFR11EQ is most commonly placed between the main output of a mixer and the input of a power amplifier. At the main output, the unit will affect all input channels. This setup is ideal for using the DFR11EQ as a feedback reducer and as an equalizer.

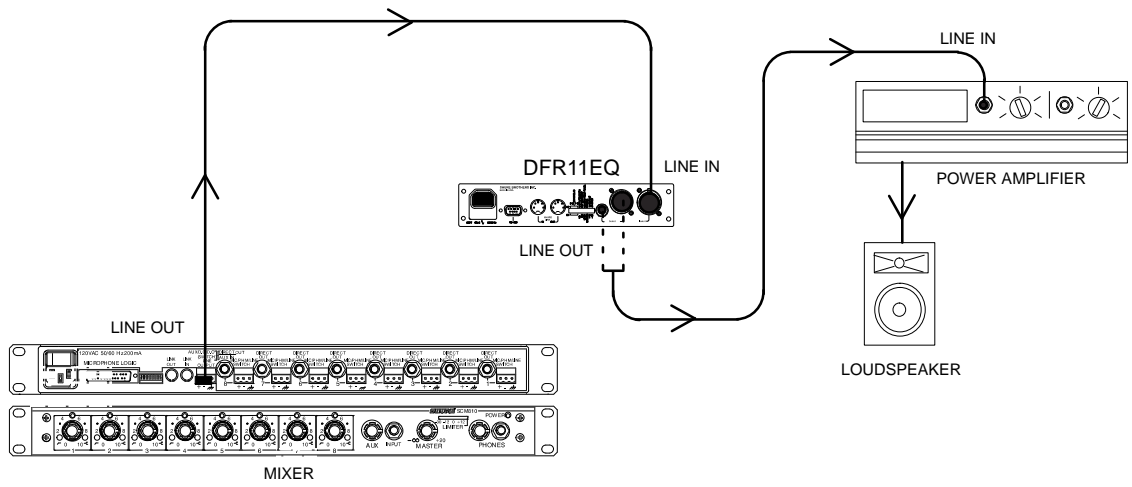

## At a Subgroup Insert

When using a multiple bus mixer, the DFR11EQ can be connected to a single subgroup insert. The unit will affect only the channels associated with that subgroup: the other channels will remain unaffected.

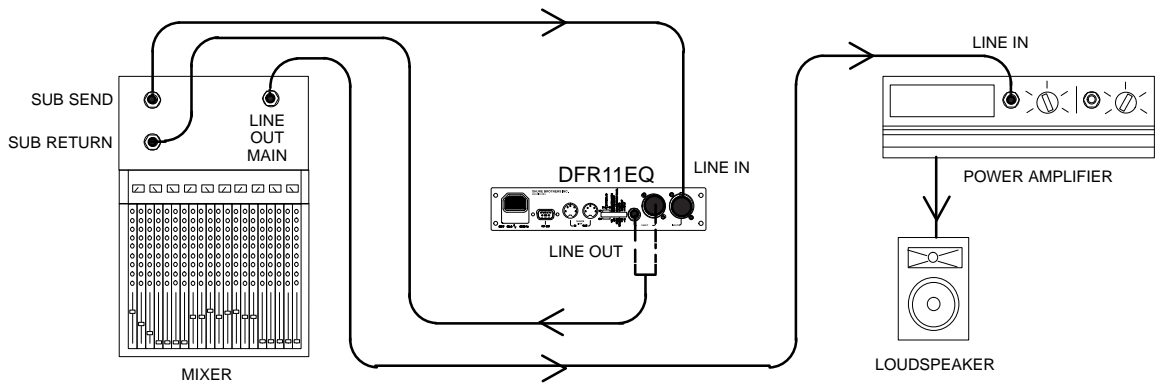

## Inserted in an Input Channel

If only a single microphone is creating feedback problems, the DFR11EQ can be inserted on that channel alone. This is especially useful for wireless microphones, because the constant movement of a performer may bring the microphone too close to the sound reinforcement loudspeakers.

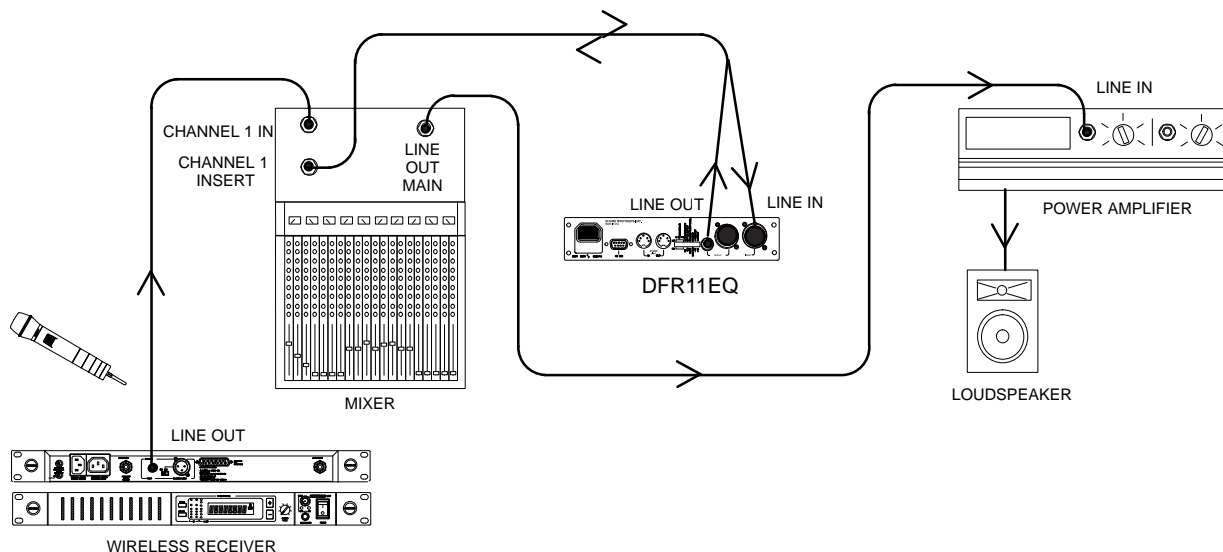

## Inserted Between Mixer and Monitor

Since monitor loudspeakers and microphones are usually in close proximity, the DFR11EQ can be connected to stabilize a monitor system. Place a DFR11EQ on the monitor output which goes to the monitor loudspeaker. For multiple monitor mixes, a DFR11EQ should be placed at the output of each monitor send.

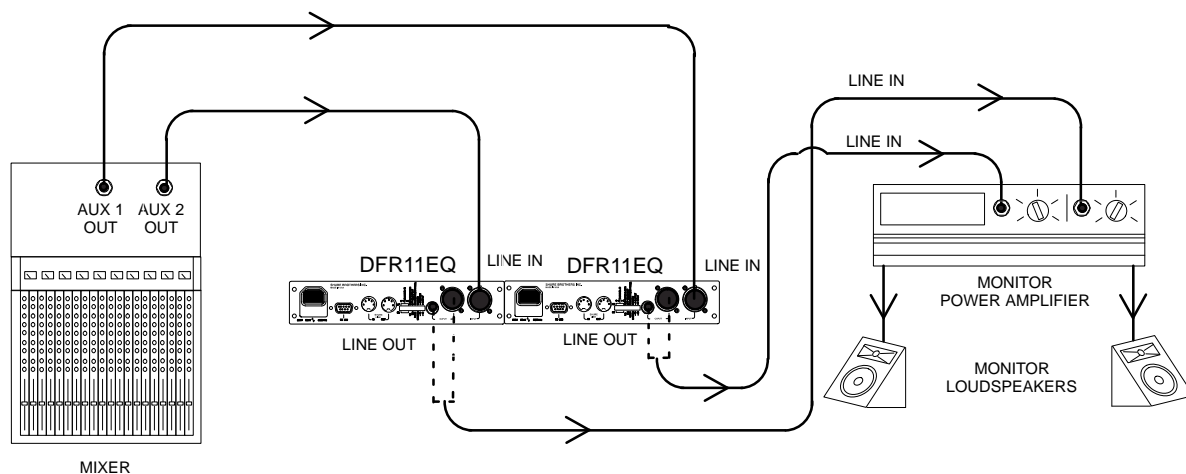

# VERSION 4 SOFTWARE

## Introduction

This section describes the Version 4 Windows-based computer interface software which allows you to utilize the full features of the Shure DFR11EQ. By connecting the DFR11EQ to your computer, you can access additional control features to customize the operating characteristics of the feedback filters. The computer interface also allows access to the built-in digital equalizer, which can be configured in one of two ways: as a 30-band, 1/3-octave, constant-Q, graphic equalizer, or as a 10-band parametric equalizer. The resulting equalization curves can be displayed in the frequency response graph for an accurate display of either the feedback filter response, EQ response, or both combined. In addition, there is a digital delay which can add up to 100 ms of delay from input to output.

### Minimum Computer Requirements

The following are the minimum requirements to run the Shure DFR11EQ software.

- One 486DX 50 MHz IBM\*-compatible computer (math coprocessor required)
- 2 MB hard drive space
- 4 MB RAM
- Windows version 3.1x, or greater
- 1 available RS-232 serial (COM) port
- One RS-232 cable to connect the COM port of the computer to the DB-9 connector of the DFR11EQ

### Connecting the DFR11EQ to a Computer via the RS-232 (COM) Port

Before connecting the DFR11EQ to the computer, determine whether the computer's RS-232 (COM) port is 9-pin or 25-pin. Use the proper cable (purchased separately). For RS-232 cable diagrams, see *Appendix C. Cables and Connectors*.

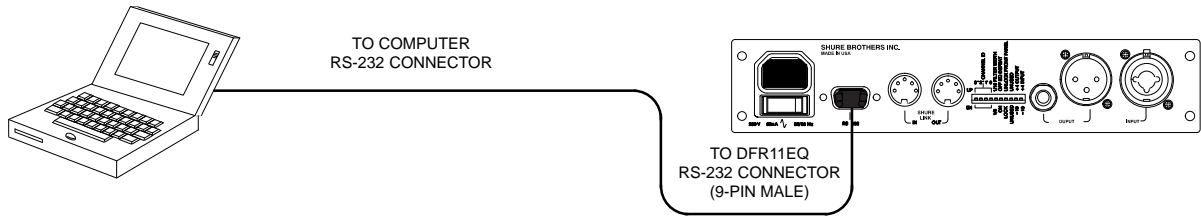

1. Connect the 9-pin plug (male) of the cable to the RS-232 port of the DFR11EQ.
2. Connect the other end of the cable to the RS-232 port of the computer.

### Software Installation

1. Insert the supplied 3.5-in floppy disk into the disk drive of your computer.
2. With Windows Program Manager active, click on the *File* heading of the main menu, then click on *Run...*
3. In the *Run* window, type "a:\setup", where "a" is the drive containing the Shure Setup disk.
4. Shure Setup will suggest a destination on your hard disk for the DFR11EQ files. Shure Setup will check the computer hardware to ensure that a coprocessor is present. Setup will also prompt you for your name and organizational information.

**NOTE:** Remember to register your software by filling out and mailing the enclosed registration card, or online via the Shure World Wide Web site ("http://www.shure.com"). This will ensure that you receive information about software updates with additional features as they become available.

## The Shure DFR11EQ Program Group

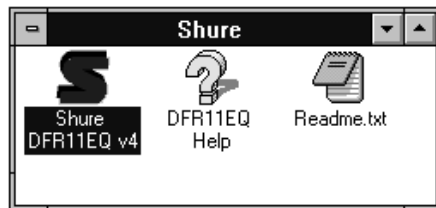

The DFR11EQ program group contains the main application icon, a Windows Help file, and a Readme file with up-to-date information. To launch the application, double-click on the DFR11EQ icon.

## Configuring the Computer Serial Port

1. Launch the DFR11EQ software.
2. Click on *Communications* in the main menu bar.
3. Click on the *COM port* option of the drop-down menu.

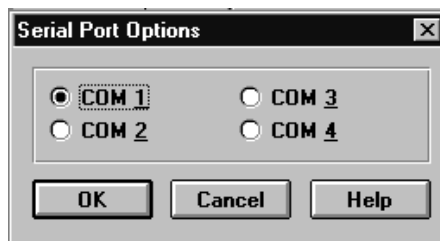

4. In the *Serial Port Options* window, select an available COM port on the computer.
5. Click on the **OK** button.

**NOTE:** The COM port selection is saved in the DFR11EQ file, and will not need to be selected again unless you need to change the hardware configuration.

## Accessing the Connected DFR11EQs



To bring the networked DFR11EQ's online, click on the **CONNECT** button of the DFR panel. Or, select the *Connect* option of the *Communications* drop-down menu of the main menu bar. The program searches for each unit connected in the network, reading the Shure Link Device ID of each.

## If You Are Upgrading from Version 3 Software...

Whenever you access a DFR11EQ with Version 3 software, the computer will ask you if you would like to upgrade the unit to Version 4. If you wish to, click on the OK button and the Version 4 software will automatically upgrade the unit. If you do not wish to, click on the NO button to access the unit without upgrading.

In Version 3 of the DFR11EQ software, scenes were stored in the DFR11EQ.INI files, so there was a 16 scene limit. In Version 4, each scene has its own file, so you can store an unlimited number of scenes on disk. When Version 4 software is installed over Version 3, the setup will automatically copy all scenes saved in the DFR11EQ.INI file into a subdirectory called SCENES. The file names will be the first 6 letters of the old scene name followed by a 2-digit number. The full scene name is stored in the description field.

## Accessing Unupgraded Version 3 DFR11EQs with Version 4 Software

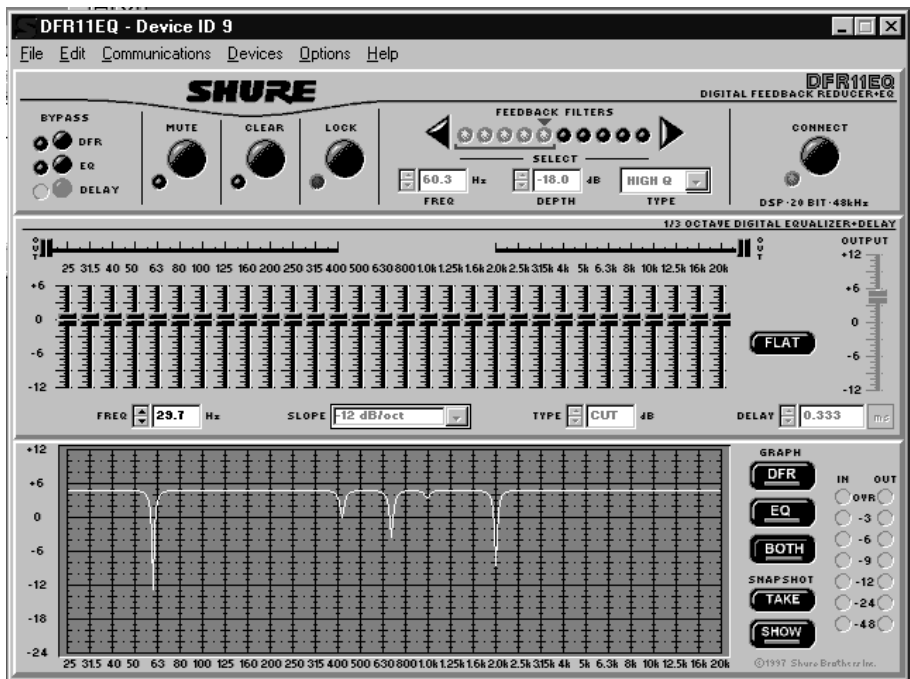

If there are DFR11EQ units which were shipped with Version 3 software in a Shure Link network, Version 4 will automatically prompt you to upgrade the software when you try to access that unit. If you do not wish to update an older unit to Version 4 software, click on **CANCEL** when prompted. You will still be able to access a DFR11EQ running on Version 3, but some of the newer options on the Version 4 software will not be available. These options will appear greyed out on the interface. See the illustration above. Options which are unavailable under Version 3 operation include: output level control, delay, IN/OUT meters, and parametric equalization. On an unupgraded DFR11EQ, you will be able to take snapshots of response curves.

# Overview

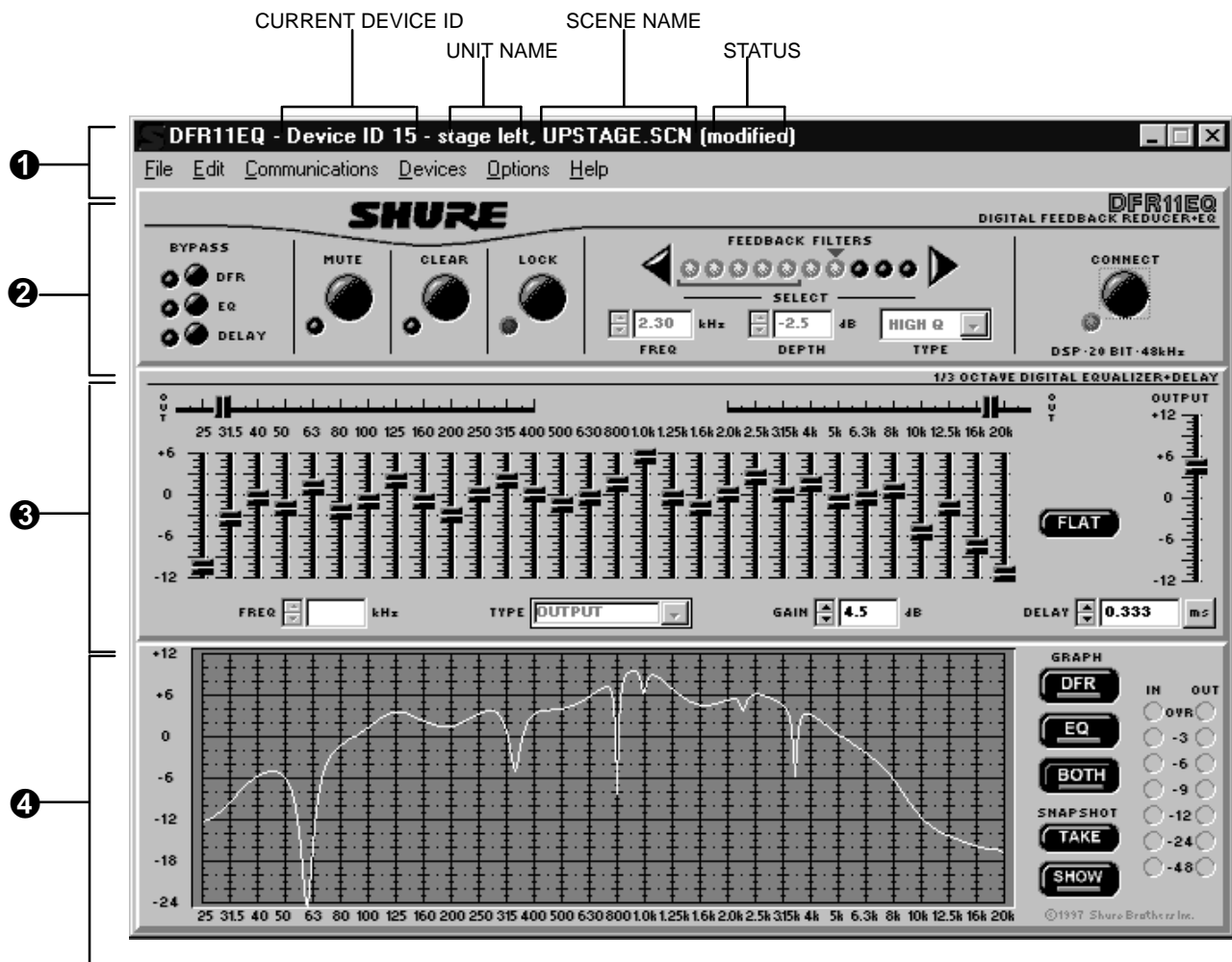

- 1 Main Menu Bar.** Through the main menu bar, you can configure the computer connection to the DFR11EQ and access other windows for configuring the DFR11EQ, such as changing equalizer types and saving scenes. When connected, the title bar above the main menu bar contains the Device ID, name of the current device, and scene name.
- 2 Feedback Reducer.** The Feedback Reducer contains many of the same controls available on the front panel of the DFR11EQ. The Feedback Reducer section allows you to view and edit the frequency, depth, and Q (bandwidth) of individual filters. There are also controls to Mute the sound system and Bypass the individual modules.
- 3 Equalizer.** The equalizer can be set to function as either a graphic equalizer or as a parametric equalizer, according to your application. This module also contains controls for the digital delay and for output levels.

*Graphic Equalizer mode* allows the DFR11EQ to act as a constant-Q, 30-band,  $1/3$ -octave graphic equalizer with up to 6 dB of boost and 12 dB of cut per band. Additional high and low frequency cut filters with a 12 dB/octave rolloff are included for setting the bandwidth limit of the sound system.

*Parametric equalizer mode* allows the unit to act as a 10-band, variable-Q, overlapping parametric equalizer with up to 6 dB of boost and 18 dB of cut per filter. Additional high- and low-shelf/cut filters are included for bandwidth limiting or loudspeaker driver level.

- 4 Response Graph.** The Frequency Response Graph allows you to accurately display the frequency response of the feedback filters (DFR), the equalizer (EQ), or the combined response (BOTH). The snapshot feature stores the present response curve, allowing you to use this as a reference point as you make changes. This module also contains the IN and OUT meters, which show the input and output signal levels.



# FEEDBACK REDUCER

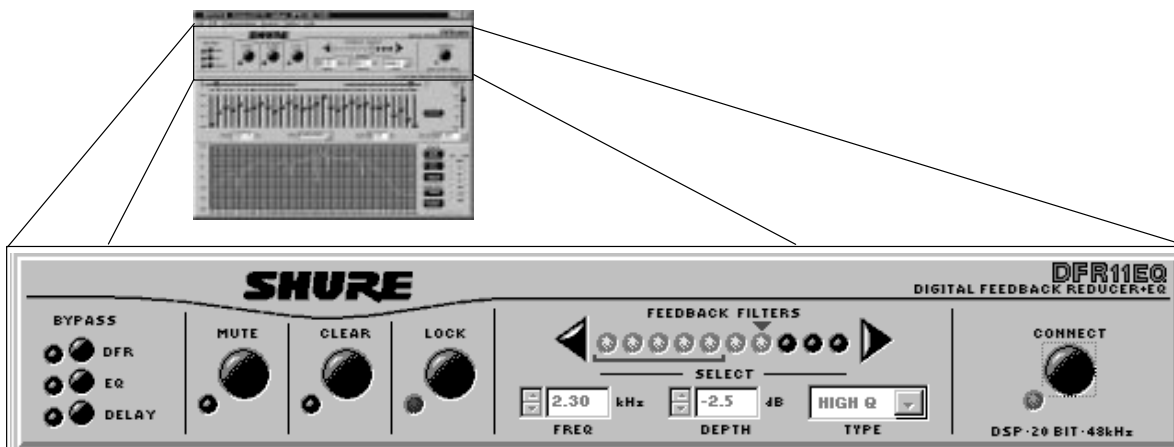

The feedback reducer section allows you to add new feedback filters or edit the frequency and depth of existing ones. Any filter can be individually set to High Q or Low Q. This section also contains a **CONNECT** button for accessing interfaced units, and buttons for bypassing the feedback filters, the equalizer, or the delay.

## Feedback Reducer Controls

### Digital Feedback Reducer (DFR) Bypass Button and LED

 Clicking on the **DFR** bypass button suspends the feedback reducer operation and removes its filters from the audio path. It does not affect the equalizer. When the LED illuminates, the feedback reducer is bypassed. This is identical to the front panel **BYPASS** button and LED.

### EQ Bypass Button and LED

 Clicking on the **EQ** bypass button removes the equalizer filters from the audio path. This button does not affect feedback reducer operation. When the LED illuminates, the equalizer is bypassed.

### Delay Bypass and LED

 Clicking on the **DELAY** button removes the delay from the audio path. The LED will illuminate and the sound will pass through unaffected by the delay.

### Mute Button and LED



To mute the audio signal of the DFR11EQ, click on the **MUTE** button. The LED will illuminate and no sound will pass through.

## Clear Filters Button and LED



Click on the **CLEAR** button to clear feedback filters. A dialog box will come up prompting you to clear one or all filters. Click on the **CLEAR ONE** to clear only the currently selected filter, or the **CLEAR ALL** button to clear all filters, then click on the **OK** button to erase a filter(s). The Clear function is active even if **LOCK** filters is active. The LED illuminates as the DFR clears the filters.

## Lock Filters Button and LED



Click on the **LOCK** button to lock the filters at their current values. The LED illuminates when the lock is active. The DFR11EQ will not set any new filters or change the depth of any existing feedback filters. This is identical to the **LOCK** button and LED on the front panel of the DFR11EQ.

## Feedback Filters Buttons, LEDs, and Related Fields



As on the front panel of the unit, there are 10 LEDs representing each of the 10 feedback filters. The LEDs illuminate from left to right, with the LEDs on the left representing the fixed filters. In order to view the settings of a specific filter, click on the right and left arrows to either side of the filter LEDs. This will move the red pointers to select a filter. When a filter is selected, the current settings of that filter will appear in the **FREQ.**, **DEPTH**, and **TYPE** fields. LED's underlined in red are set as fixed filters. You can click on a filter to select it, then edit that filter directly by clicking on the arrow buttons beside the **FREQ.**, **DEPTH**, and **TYPE** fields.

**FREQ.** — This field displays the frequency center of the selected filter. Click on the  $\uparrow$  and  $\downarrow$  buttons to adjust the frequency of the filter, or type the desired frequency in the field.

**DEPTH** — This field displays the amount of cut the filter required to stop that frequency from feeding back. Click on the  $\uparrow$  and  $\downarrow$  buttons to adjust the depth of the cut or boost in 5 dB increments, or type the desired depth in the field.

**TYPE** — This field displays the Q, or width, setting of the selected filter. The type of each filter can be selected individually using this field. Click on the  $\downarrow$  button beside the field to reveal the two options: Low Q and High Q. Select one of these options.

## Connect Button and LED



Clicking the **CONNECT** button brings the DFR11EQ plugged in to the computer online, along with any other DFR11EQs networked via Shure Link. When the LED illuminates green, the connected units are online. When the LED is off, the units are operating without the computer interface and the software is running offline. When the LED illuminates red, the software is reconfiguring a unit as a graphic or parametric equalizer.

## Feedback Reducer Options

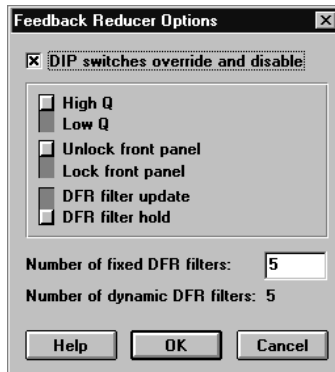

The *DFR11EQ Settings* window contains options for controlling the DIP switches and setting fixed and dynamic filters. To access the *DFR11EQ Settings* window:

1. Click on *Options* in the main menu bar.
2. Select the *Feedback Reducer...* option of the drop-down menu.

### DIP Switches Override and Disable

Clicking on the *DIP switches override and disable* box disables the Filter Bandwidth, Front Panel Lock/Unlock, and Hold/Update DIP switches to prevent tampering. Once the *DIP switches override and disable* is activated, an X will appear in the box and the High Q/Low Q selection, Front Panel Lock/Unlock, and DFR Filter Update/Hold options will be controllable only from the computer. The DIP switch override does not affect the input and output level or Device ID DIP switches.

### Setting High Q or Low Q Filters

The High Q and Low Q option is the same as the Filter Bandwidth DIP switch options on the back of the unit. For definitions of High Q and Low Q, see *DFR11EQ Theory*.

### Lock/Unlock the Front Panel

The Lock/Unlock front panel option is the same as on the Front Panel Lock/Unlock DIP switch. This option protects the unit from tampering.

### Hold/Update DFR Filters

The Hold/Update DFR Filter option is the same as on the Hold/Update DIP switch. See *Hold/Update* under *Setup for Feedback Control*.

### Setting Fixed and Dynamic Filters

DFR11EQ feedback filters are set in one of two modes: *Fixed* or *Dynamic*. For definitions of these two modes, see *DFR11EQ Theory*. The DFR11EQ comes factory preset with 5 fixed and 5 dynamic filters.

To change number of Fixed and Dynamic filters from the *Feedback Reducer Options* window:

1. Place the cursor in the *Number of Fixed DFR Filters* field by using the mouse.
2. Type in the desired number of fixed filters. The remaining filters automatically become dynamic.
3. Click on the **OK** button to accept the changes.

# EQUALIZER

The Equalizer module of the DFR11EQ Version 4 software can be set to work as a parametric equalizer or as a graphic equalizer, according to your needs. There is an Equalizer Options window for you to set the equalizer type.

## Graphic Equalizer (default)

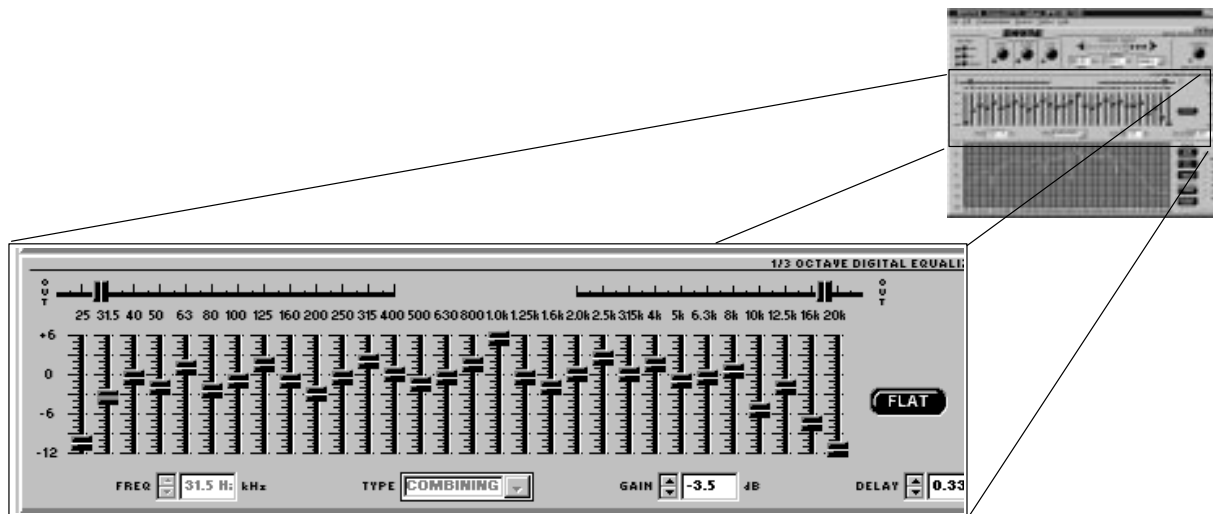

In Graphic Equalizer mode, the software allows the DFR11EQ to act as a constant-Q, 30-band,  $1/3$ -octave graphic equalizer with up to 6 dB of boost and 12 dB of cut per band. Additional high and low frequency cut filters with a 12 dB/octave rolloff are included for setting the bandwidth limit of the sound system.

## Setting up the Graphic Equalizer

The equalizer is already set up in graphic mode when the software is first installed. However, in order to change from parametric to graphic mode:

1. Click on *Options* in the main menu bar.
2. Click on *Equalizer...*
3. In the *Equalizer Options* window, click on the **Graphic Equalizer** button.
4. Click on the **OK** button.
5. If a DFR11EQ is currently online, click on the **CONTINUE** button when the computer prompts, "The equalizer in the connected DFR11EQ will be reset to graphic mode..."

The LEDs on the DFR11EQ will flash on and off several times while the software reconfigures the unit to work as a graphic equalizer.

## Combining vs. True 1/3-Octave Equalization

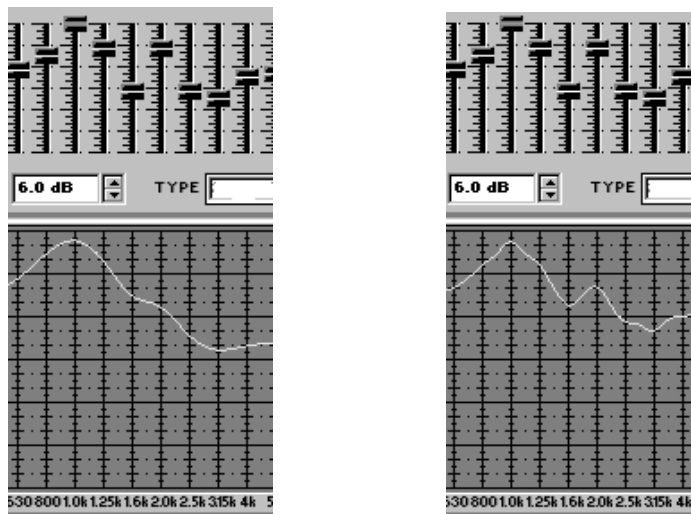

**Combining (default)...** When the graphic equalizer is setup for combining equalization, the band filters are combined so that the response curve is smoothed out, creating a more even gradation of equalization. In the illustrations above, each showing the same section of an equalizer and the response graph, the one on the left is set to Combining mode. The peaks and troughs on the response graph are smoothed out.

**True 1/3 octave...** When the graphic equalizer is set up for true 1/3-octave equalization, the band filters act more independently from each other, as shown in the example on the right above. The illustration on the right has the same slider settings as the one on the left, but is set in True 1/3 Octave mode, so the peaks and troughs in the resulting response curve are more prominent.

## Adjusting Bands

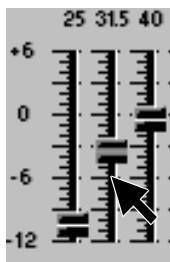

The DFR11EQ graphic equalizer looks and functions just like a conventional graphic equalizer. Each slider controls a 1/3-octave band centered around the frequency indicated above each slider. When a slider is selected, the center of the slider turns green. To move the slider, use the mouse to drag the slider to the desired level.

## Low-Frequency Roll-Off

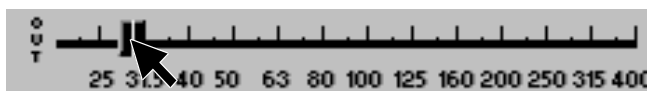

The *Low frequency roll-off* slider determines the corner frequency of the highpass filter. To adjust the Low frequency roll-off, drag the slider to the desired frequency. You can also use the ← and → keys on the computer keyboard to move this slider.

## High-Frequency Roll-Off

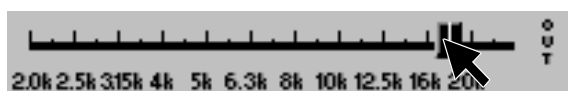

The *High frequency roll-off* slider determines the corner frequency of the lowpass filter. To adjust the High frequency roll-off, drag the slider to the desired frequency. You can also use the ← and → keys on the computer keyboard to move this slider.

## Graphic Equalizer Fields and Buttons



**FREQ.** — This field displays the frequency center of the selected filter. The ↑ and ↓ buttons are inactive for graphic equalizer sliders, but is active for the high- and low-frequency sliders.

**TYPE** — The Type field displays the type of equalizer filter: combining or true  $1/3$ -octave.

**GAIN** — The GAIN field displays the amount of cut or boost in dB applied to the selected filter. The ↑ and ↓ buttons or type a value in the field to adjust the gain or cut of the filter. This field is inactive for the high- and low-rolloff filters.

## Flat Button

**FLAT** The **Flat** button resets all the equalizer filters sliders back to the 0 dB position and it resets the high- and low-frequency rolloff sliders to OUT. The FLAT button can be undone by selecting the *UNDO* option from the *EDIT* option in the main menu bar.

# Parametric Equalizer

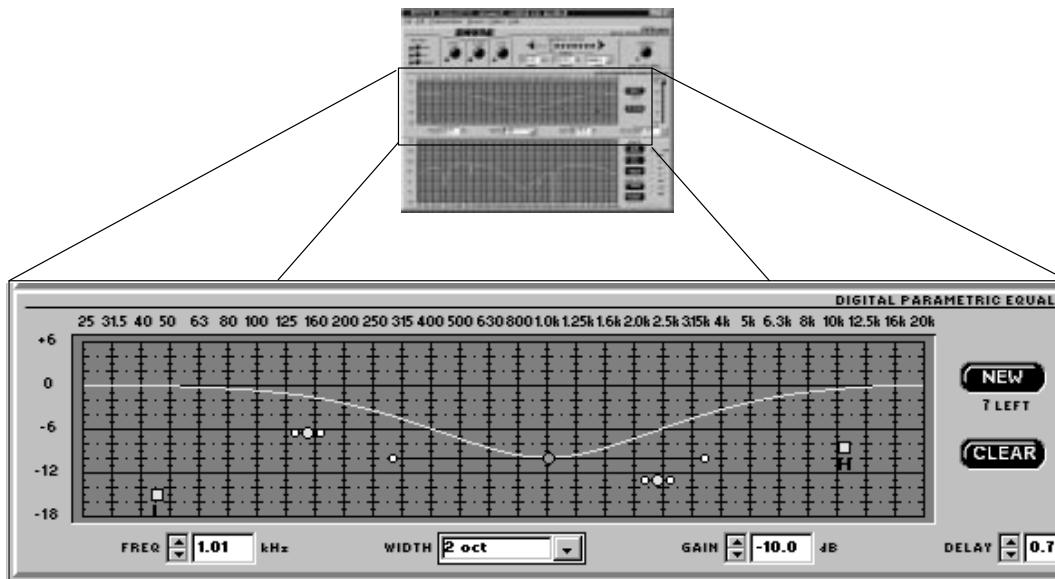

The equalizer of the DFR11EQ can be set to work as a 10-band parametric equalizer. Each filter has adjustable frequency, gain, and width. In addition, there are shelving high- and low-frequency rolloff/shelf filters. Parametric filters are represented as dots, while the High- and Low-frequency filters are represented as squares. When a filter is selected, the dot representing that filter changes color to indicate that it has been selected. Parametric filters can be edited using cut, copy, and paste.

## Setting up the Parametric Equalizer

1. Click on *Options* in the main menu bar.
2. Click on *Equalizer...*
3. In the *Equalizer Options* window, click on the **Parametric Equalizer** button.
4. Click on the **OK** button.
5. If a DFR11EQ is currently online, click on the **CONTINUE** button when the computer prompts, "The equalizer in the connected DFR11EQ will be reset to parametric mode..."

The LEDs on the DFR11EQ will flash on and off several times while the code for the parametric equalizer is being loaded.

## Parametric Equalizer Fields and Buttons



**FREQ.** — This field displays the center frequency of the selected filter. Click on the  $\uparrow$  and  $\downarrow$  buttons to adjust the frequency of the filter, or type the desired frequency in the field.

**WIDTH** — The WIDTH field displays the width of the selected filter. Clicking on the  $\downarrow$  button will reveal a drop-down menu with the available options. Select one of these to change the width, or type in the desired width. If a shelving filter is selected, the field changes to TYPE containing SHELF as the option. Once the high or low filter cuts more than  $-18$  dB, the filter becomes a rolloff filter, so the name of this field changes to TYPE and it displays the slope of the filter. The slope of the rolloff filter is adjustable from  $-6$  to  $-24$  dB/octave.

**GAIN** — The GAIN field displays the amount of cut or boost in dB applied to the selected filter. Clicking on the  $\uparrow$  and  $\downarrow$  buttons will adjust the boost or cut in gain of the filter. With the high and low shelving filters, the response will shelf at the level of the gain filter. However, once the high or low filter cuts more than  $-18$  dB, the filter becomes a rolloff filter.

## Adjusting Parametric Filters

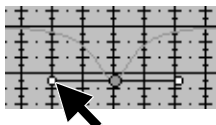

Adjusting a parametric filter is simple. Point and click on a filter. It will change colors to show that it is selected. Then, drag the filter to the desired frequency and level. A parametric filter can be used to cut or boost over a desired bandwidth. Notice that each filter dot also has wings with two smaller dots. drag these to adjust the Q, or width, of the filter to affect a smaller or larger bandwidth. The Q can also be adjusted from the WIDTH field: click on the ↓ button to reveal the drop-down menu which contains all of the possible bandwidth options. The parametric filters can overlap. However, too many overlapping filters may cause the EQ to distort at certain frequencies.

## NEW Button



Click on the **NEW** button to generate a new parametric filter. Each new parametric filter initially appears at 1 KHz, 0 dB, 2/3-octave. The number of remaining filters is displayed below the **NEW** button.

## Clear Button



The **CLEAR** button resets all the filters.

## High- and Low-Frequency Roll-Off/Shelf Filters

Like the graphic equalizer, the parametric equalizer offers both high- and low-frequency filters. These are the filter squares labelled “H” and “L” — that is, respectively, High and Low. When the parametric equalizer is first set, the high- and low-frequency roll-off filters are set for a flat response. In order to change either filter, drag the square. The software will not permit the high- and low-frequency shelf/rolloff filters to cross.

**Shelf** — The Shelf filters can be adjusted from +6 dB to -18 dB in 1/2 dB increments. Shelving is extremely useful for boosting flat frequency response, tempering very sibilant vocal microphones, or enhancing the sound of off-axis lavalier microphones. The illustration below shows how shelving filters can be used to boost or cut certain frequencies in a sound system.

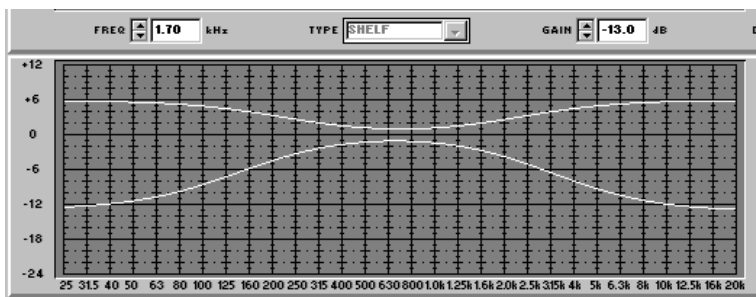

**Rolloff** — There is an additional step below -18 dB which set the gain of the shelf to cut. When the filters reach cut, they change from shelf filters to rolloff filters. When in rolloff mode, the GAIN field turns into the SLOPE field, and clicking on the ↑ and ↓ buttons will adjust the slope of the rolloff. The slope can be adjusted from 6 dB/octave to 24 dB/octave in 6 dB/octave steps. Please not that these slopes are nominal values, so slopes at high frequencies will be more steep than those at low frequencies. Rolloff filters are ideally used for attenuating the audio signal where extraneous noise, excessive proximity effect, or other unwanted noise is present. The illustration below shows a response curve with high- and low-frequency rolloff filters.

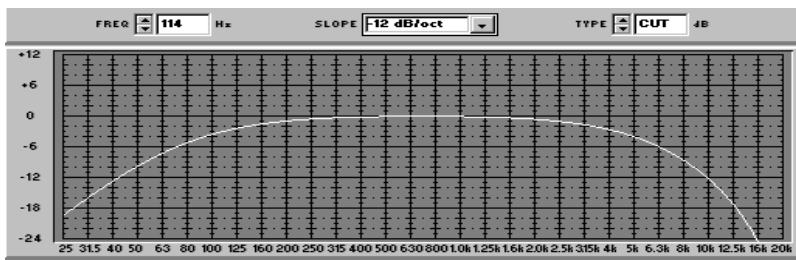



---

# Cutting, Copying, and Pasting Parametric Filters

## Cutting a Selected Parametric Filter

1. Click on the desired parametric filter.
2. Click on *Edit* in the main menu.
3. Click on *Cut*.

## Copying a Selected Parametric Filter

1. Click on the desired parametric filter.
2. Click on *Edit* in the main menu bar.
3. Click on *Copy*.

## Pasting a Selected Parametric Filter

1. Cut or Copy the desired parametric filter.
2. Go to the unit and scene where you would like to place the filter.
3. Click on *Edit* in the main menu bar.
4. Click on *Paste*.

---

## Other Equalizer Options

To access the Equalizer Options window:

1. Click on *Options* in the main menu bar.
2. Click on *Equalizer...*

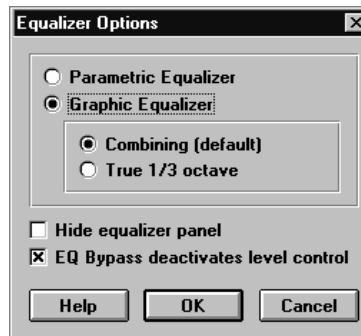

## Hiding and Unhiding Equalizer Panel

1. Click on the **Hide equalizer panel** box. A "X" in the box indicates that the equalizer panel will be hidden. To unhide the equalizer panel, simply click on the box to remove the "X".
2. Click on the **OK** button.

## EQ Bypass Deactivates Level Control (Default On)

When this is active, the DFR11EQ will bypass the Level Control when the EQ Bypass is on. This feature allows you to compare the equalized and unequalized sound by using the EQ Bypass button without having to readjust the output level.

# DELAY

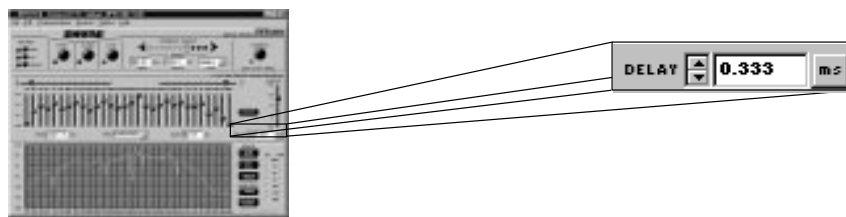

There are some potential problems with the arrival of sound in systems utilizing multiple loudspeakers. The DFR11EQ Delay is designed to solve two of these problems: time alignment and phase cancellation.

## Delay for Solving Time Alignment Problems

**Problem:** Some larger sound systems may utilize loudspeaker fill systems. One loudspeaker may not be enough for a large hall because of power limitations. A fill loudspeaker may be placed farther in front of the main speaker to augment the sound from the main loudspeaker. This may cause the sound from the fill loudspeaker to arrive at the listener earlier than that from the main loudspeaker. To the audience, it will seem like the sound is coming from the wrong place when the sound from the fill loudspeaker arrives first.

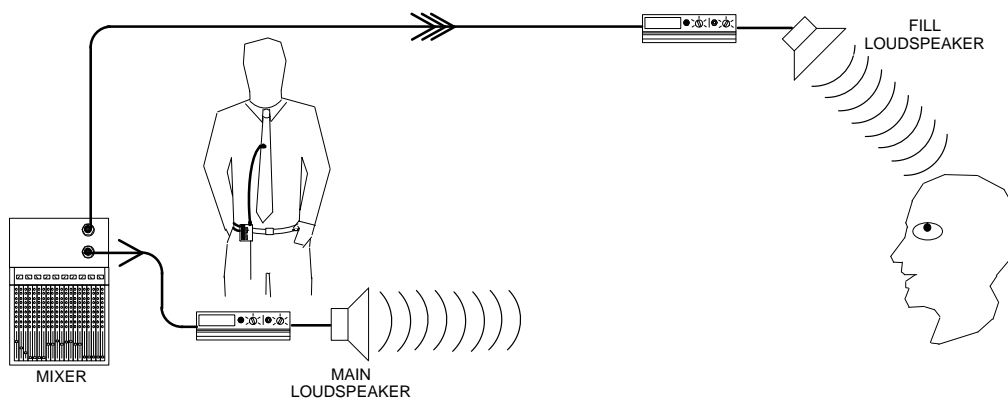

**Solution:** The delay in the DFR11EQ can be used to solve this problem. Place a DFR11EQ along the audio path to the amplifier of the fill loudspeaker, then set it to the proper amount of delay. The DFR11EQ with Delay will hold that audio signal in memory, releasing it to the fill loudspeaker only when it is in time with the sound from the main loudspeaker, so the sound from both loudspeakers will arrive at the audience at the same time. Now, the audience will perceive the sound coming from the correct place.

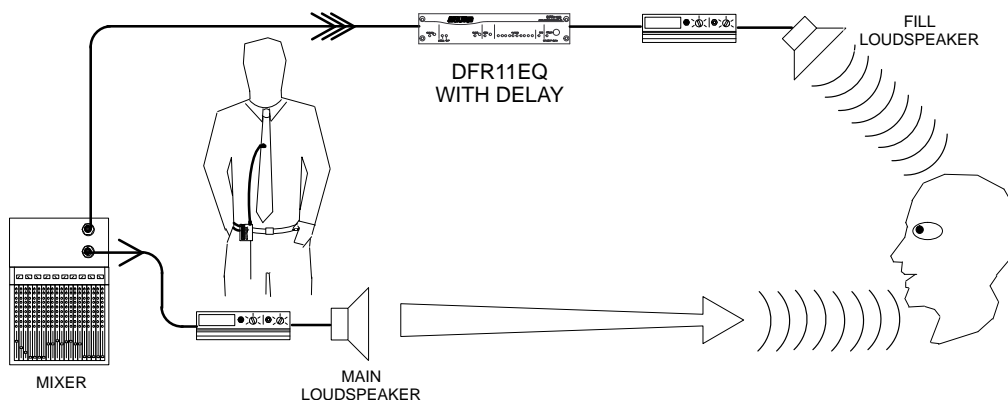

## Delay for Solving Phase Cancellation Problems

**Problem:** Phase cancellation can occur when two loudspeakers are near each other but not aligned. The two speakers can be seen in the illustration below. The waves represent the sound coming from each. The sound waves coming from the main and remote loudspeakers are out of phase. Because they are out of phase, the sounds interfere with each other, degrading audio quality. The illustration below shows how sound waves cross, causing phase cancellations.

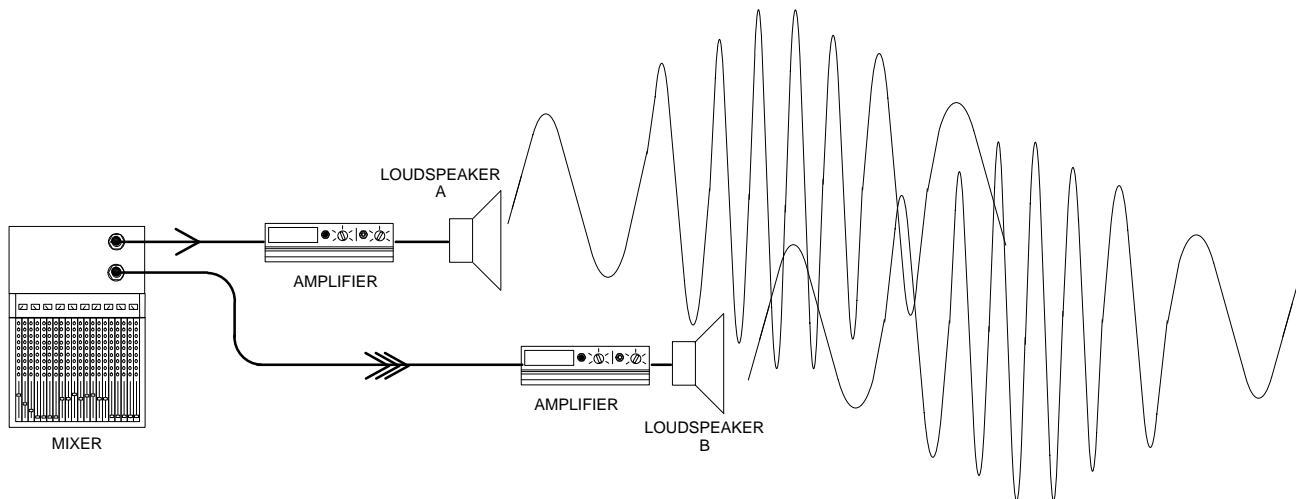

**Solution:** The DFR11EQ Delay can be used to stall the signal to loudspeaker B just long enough so that when it does come out, it is in phase with the sound from the loudspeaker A. When in phase, the waves reinforce each other to maintain audio quality. The following illustration shows how the DFR11EQ delay works in a sound system.

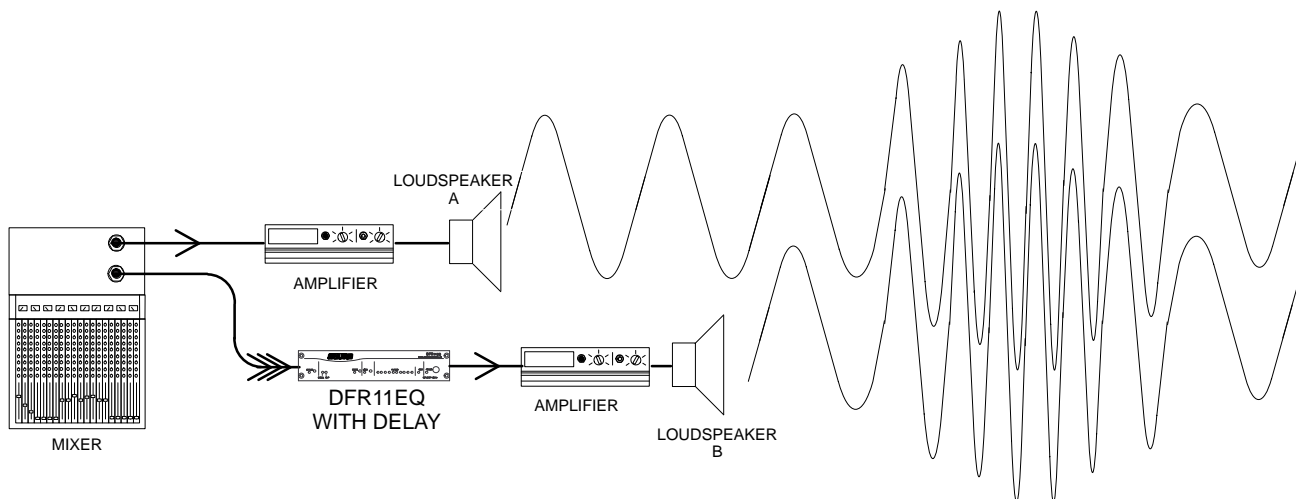

## Setting Delay in Milliseconds (Default)



Delay in milliseconds is the default for setting delay in Version 4 software. When set in milliseconds, you do not need to adjust the DFR11EQ for temperature. To set delay in milliseconds, click on the ↑ and ↓ buttons, or type the amount in the DELAY field.

## Setting Delay by Distance

Setting delay by distance is very easy, but you should account for air temperature. As the temperature gets hotter the speed at which sound travels increases, so the delay time decreases. Version 4 software allows you to adjust for different temperatures when setting delay by distance.

To set delay in distance:

1. Click on the button to the right of the *DELAY* field on the main window to reveal a drop-down box.

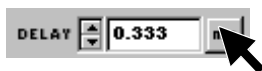

2. Select inches, feet, or meters.
3. Measure the distance from the main loudspeaker to the remote loudspeaker.
4. Click on *Options* in the main menu bar.
5. Click on *Delay...*

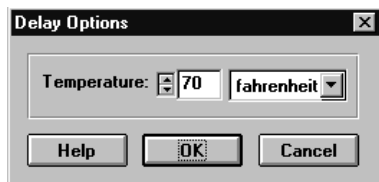

6. Measure the air temperature.
7. In the second field, click on the ↓ button to reveal a drop down box. Select Celsius or Fahrenheit.
8. In the first field, click on the ↑ and ↓ buttons to lower or raise the temperature. Set this field to the temperature in the room. The default is 70, a typical room temperature.
9. Click on the **OK** button to accept the changes.

# OUTPUT CONTROLS

## IN/OUT Level Meters and Output Control

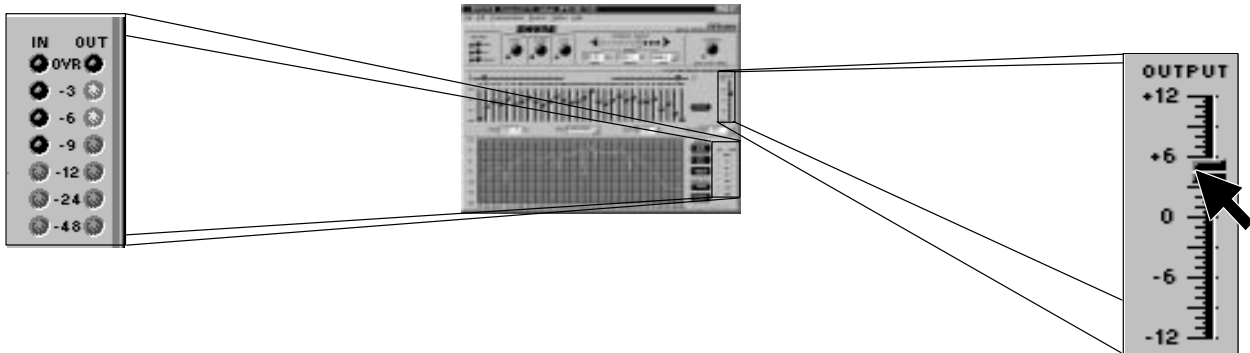

The IN and OUT level meters located next to the response curve graph display the levels of the input and output in dB. When the levels go into the red, the unit is clipping. This is a useful tool for observing gain loss due to equalization settings. To compensate, you can use the OUTPUT slider located near the output controls. Raising or lowering this slider will raise or lower the gain of the output. As the output level is adjusted, the Response Curve Viewer will adjust accordingly, moving the current response curve to the new level on the graph. If you take a snapshot before adjusting the output level, the snapshot will remain at the original output level.

To adjust the output gain, drag drop the OUTPUT slider. Or, select the output slider by clicking on it, then click on the ↑ and ↓ buttons next to the GAIN field to raise and lower the levels.

To activate the IN/OUT level meters:

1. Click on *Options* in the main menu bar.
2. Click on *Display Level Meters* option. A check will appear next to this option to indicate that it is active.

**NOTE:** While the IN/OUT level meters are running, the NEW indicator on the DFR11EQ unit will continually flicker. This is normal operation while the IN/OUT meters are active.

## Reversing the Output Signal Polarity

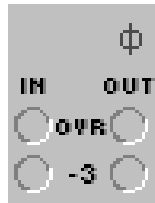

This option is designed for sound systems where there is a component which inverts the polarity of the signal, bringing it out of phase with the rest of the equipment. Inverted polarity can cause phase cancellations in the audio. Using this option of the DFR11EQ Version 4 software, you can digitally invert the audio signal in order to compensate. This will save the time and expense spent in wiring customized cables. When the polarity is reversed, a red Ø appears over the OUT Meter.

To use the DFR11EQ with software Version 4 as an audio signal polarity inverter:

1. Click on *Options* in the main menu bar.
2. Click on *Reverse Output Polarity*. A check will appear next to this option to indicate that it is active.

# RESPONSE GRAPH

This section describes how to use the Response Graph, which displays a response curve showing the effect of the DFR11EQ on the audio signal.

## Response Curves

### DFR Response Curves



Clicking on the **DFR** button displays the feedback filter frequency response curve on the graph. This curve shows the response of all deployed feedback filters. Here you can see the frequency, depth, and Q of each filter.

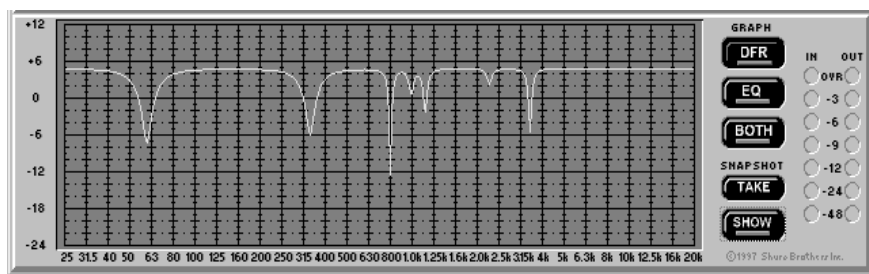

### EQ Response Curves



Clicking on the **EQ** button displays the graphic equalizer frequency response curve on the graph. Use this curve as an aid in setting up the equalizer and output level control.

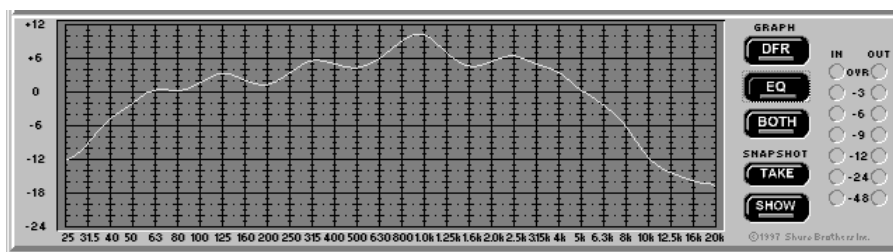

### Both



Clicking on the **BOTH** button displays the composite response of the equalizer and output level control and the deployed feedback filters. Here you can see how the equalized sound is affected by the feedback filters.

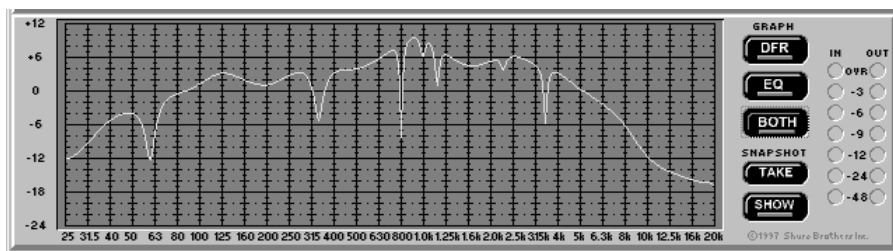

## Hide Response Curve Graph

If you have finished working on the Response Curve Graph and need to free some space on the Windows desktop, you can hide the graph.

1. Click on *Options* in the main menu bar.
2. Click on *Response Graph...*
3. Click on the **Hide response graph panel** box.
4. Click on the **OK** button.

## Snapshots

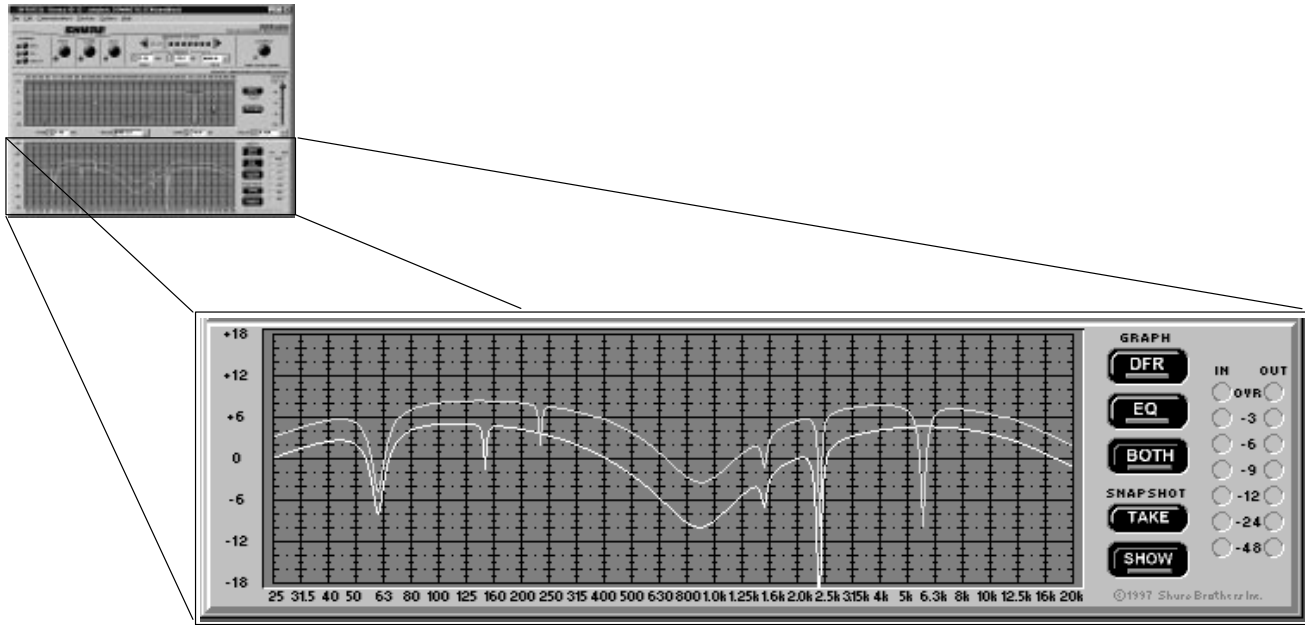

One of the new features of software Version 4 is the ability to take snapshots of a frequency response curve. A snapshot allows you to view a tracing of the original response curve while making changes. This is an effective setup tool. In the illustration above, the upper curve is the frequency response of the current settings, while the lower curve is the snapshot.

In order to use a snapshot:

1. Click on the **TAKE** button.
2. Click on the **SHOW** button.
3. Make changes to the filter or equalizer settings.

**NOTE:** If there have been no changes to the curve since the snapshot was originally taken, the snapshot of the curve is directly under the current curve because they are still exactly the same. Once you make changes, the current curve will change and you will be able to see the snapshot underneath.

# SHURE LINK NETWORKS

## Shure Link Connections

Up to 16 DFR11EQ's can be linked together and controlled from a single computer. Each unit comes supplied with one 5-pin DIN cable for linking.

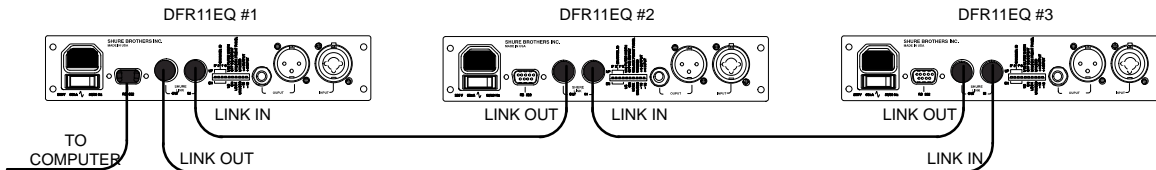

1. Assign each unit a Device ID (0 through 15) via the DIP switches on the rear panel (see *Shure Link Device ID*, in the *Hardware* section of this manual).

**NOTE:** All units must have unique Device ID's. The software will not allow adjustments to be made to a Device ID which has multiple DFR11EQ's, because those units may be configured differently.

2. Using the supplied 5-pin DIN cable, connect the Shure Link OUT of the first unit (the one connected directly to the computer) to the Shure Link IN of the next unit. Repeat this connection for each unit to be networked. **The last unit in the chain should be connected from its Shure Link OUT to the Shure Link IN of the first unit.** This creates the loop necessary for all of the networked units to communicate with the computer.

**NOTE:** Although a standard MIDI cable can be used to link units, Shure Link is not MIDI compatible.

## Shure Link Options

### Shure Link Device Menu

The *Device* menu displays the following information:

Devices Options Help			
Name Device..			
09	<unnamed>	<untitled.scn>	DFR+GEQ 3X
✓ 12	stage right	DOWNSTG.SCN (modified)	DFR+PEQ+DLY
15	stage left	UPSTAGE.SCN (modified)	DFR+GEQ+DLY

- 1 **Device ID.** This column lists all the Device ID's that are active in the network. The Device ID is assigned through the DIP switches. See *Shure Link Device ID* under *Introduction*. This column also indicates when there are multiple units.
- 2 **Unit Name.** See *Naming a DFR11EQ*.
- 3 **Scene.** This column lists the name of the scene that is active in the device and the status of that scene if it has been modified. Once a modified scene has been saved to disk, the modified status changes.

- 4 **Configuration.** This column lists the signal processing modules active in that scene. The modules are listed in abbreviations as follows:  
 DFR = Digital Feedback Reducer  
 GEQ = Graphic Equalizer  
 PEQ = Parametric Equalizer  
 DLY = Delay  
 3X = DFR11EQ Version 3.X  
 DFR MEM ERR = Corrupted unit

**NOTE:** If there are multiple DFR11EQ's using the same Device ID, that Device ID will appear grayed out in the menu. Those units will be inaccessible to computer control. The software is designed this way to avoid problems which may occur when multiple units on the same Device ID are performing different functions. To access multiple units, please make sure that each unit has been assigned a different Device ID.



## Shure Link Device Selection

In order to select a Device ID on a Shure Link network:

1. Click on *Device* in the main menu.
2. In the Device menu, click on the desired Device ID.

The Device ID will appear beside the DFR11EQ heading in the title bar at the top of the main window, indicating that the unit with that Device ID will receive computer commands.

## Naming a DFR11EQ

Devices can be named...

In order to name a DFR11EQ in a network:

1. Click on *Device* in the main menu.
2. In the Device menu, click on *Name Device...* The *Name Device* window will appear.

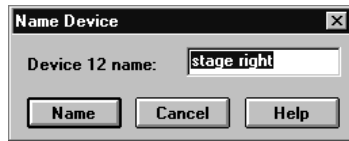

3. In the *Name Device* window, type in the desired name.
4. Click on the **OK** button. The name will appear in the title bar.

---

# MAINTENANCE

---

## Scenes

Once a DFR11EQ has been set up with a desired combination of settings, these settings can be stored on disk as a Scene. Although the DFR11EQ automatically saves the current scene in internal memory, other scenes can be saved to disk. Scenes are useful for reducing setup time when multiple units require similar settings. Scenes are also useful for multi-purpose sound system, or events which require changing settings “on the fly”.

### To Save a Scene to Disk

Scenes are saved with the extension .SCN. To save a scene:

1. Click on *File* in the main menu bar.
2. Select the *Save Scene...* option of the drop-down menu.
3. In the *Description* field, type a description of the scene.
4. In the *File Name* field, type the name of the scene.
5. Click on the **OK** button.

### To Recall a Scene from Disk

Once a scene has been saved, the Windows software can be used to reload that scene from disk and recall it to a DFR11EQ. To recall a scene:

1. Click on *File* in the main menu bar.
2. Select the *Scenes...* option of the drop-down menu.
3. Select *Recall Scene...*
4. On the *Scene* window, select the desired scene.
5. Select the desired scene name.
6. Click on the **OK** button.

---

## Customizing Graph Colors

The graph colors on the Version 4 software interface can be customized to fit individual tastes. This can help make the display more visible or aesthetically pleasing. To change the color of an item on the interface:

1. Click on *Options* in the main menu bar.

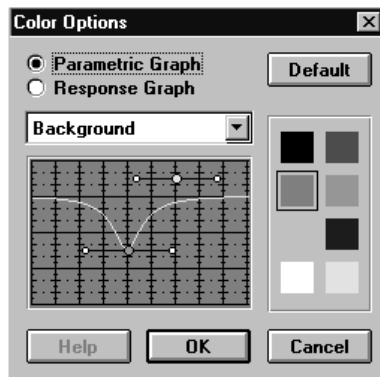

2. Click on *Colors...*
3. In the *Color Options* window, select **Parametric Graph** or **Response Graph**.
4. In the field just below the Parametric Graph/Response Graph buttons, click on the ↓ button.
5. In the drop down menu, select the item you would like to assign a new color. The space below the field will display the selected item.
6. On the colored squares beside the display, select the desired color.
7. Click on the **OK** button.

**NOTE:** The **Parametric** option of the *Color Options* window will be disabled if the software is configured for graphic equalizer mode.

---

## Exiting the DFR11EQ Application

### To Exit

1. Click on *File* in the main menu bar.
2. Select the *Exit* option of the drop-down menu.

# Printing DFR11EQ Settings

If you are documenting a sound system, the DFR11EQ Version 4 offers the option of printing out a hardcopy report showing the settings of a selected unit. To print out a hardcopy of this report:

1. Click on *File* in the main menu bar.
2. Click on *Print...*
3. Select any of the desired print options available.
4. Click on the button of the **Name:** field to display a drop-down list of available printers, then select a printer.
5. Click on the **OK** button.

DFR11EQ		06/30/97	
Device ID	15	10:58 AM	
Device Name	Main System		
Scene Name	MAIN.SCN		
Version		Microcontroller Code	3.0.1.3
Product Code	Parametric	DSP Boot Code	3.0.0.0
Windows Code	1.73	Hardware Code	S2423805492
DSP Code	4.1.0.0		
Bypass	none	Delay	0.000 ms
Lock	Off	Temperature	
DIP Switch Lockout	Off	Level	-0.0 dB
Feedback Filters	High Q	Mute	Off
Fixed Filters	5	Invert	Off
Dynamic Filters	5		

Feedback Filters

frequency	depth	type	mode
110 Hz	-9.0 dB	High Q	fixed
1.24 kHz	-6.0 dB	High Q	fixed
5.10 kHz	-3.0 dB	High Q	fixed
2.20 kHz	-12.0 dB	High Q	fixed
5.50 kHz	-8.0 dB	High Q	fixed

frequency	depth	type	mode
400 Hz	-6.0 dB	High Q	dynamic
			dynamic
			dynamic
			dynamic
			dynamic

Low-Cut Filter (High Pass)

frequency	type	gain
36.9 Hz	-24 dB/oct	cut

High-Cut Filter (Low Pass)

frequency	type	gain
14.0 kHz	-12 dB/oct	cut

EQ Filters -- Parametric EQ

frequency	bandwidth	gain
5.23 kHz	2/3 oct	-2.5 dB
86.4 Hz	0.275 oct	-3.0 dB
263 Hz	1 oct	-2.5 dB
673 Hz	0.575 oct	1.5 dB
120 Hz	1/40 oct	-18.0 dB

frequency	bandwidth	gain
60.0 Hz	1/40 oct	-18.0 dB

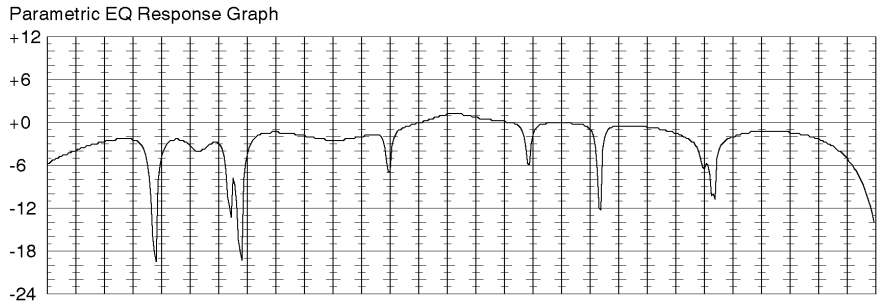

# APPENDIX A. SPECIFICATIONS

## Frequency Response

20 to 20k Hz  $\pm$  1.0 dB re 1 kHz

## Dynamic Range

104 dB minimum, A-weighted, 20 Hz to 20 kHz

## Sampling Rate

48 kHz

## Digital-to-Analog, Analog-to-Digital Conversion

20 bit resolution

## Voltage Gain

- 1 dB  $\pm$  1dB (power off)
- 0 dB  $\pm$  2 dB (equal input and output sensitivities)
- 12 dB  $\pm$  2 dB (input -10 dBV, output +4 dBu)
- 12 dB  $\pm$  2 dB (input +4 dBu, output -10 dBv)

## Impedance

Input: 47 k $\Omega$   $\pm$  20% actual  
Output: 120  $\Omega$   $\pm$  20% actual

## Input Clipping Level

- +18 dBu minimum (at +4 dBu setting)
- +6 dBu minimum (at -10 dBV setting)

## Output Clipping Level

- +18 dBu minimum (at +4 dBu setting)
- +6 dBu minimum (at -10 dBV setting)

## Total Harmonic Distortion

< 0.05% at 1 kHz, +4 dBu, 20 to 20 kHz

## LED Signal Indicators

Clip: 6 dB down from input clipping

## Propagation Delay from Input to Output

< 1.0 ms, all filters set to Flat (0 ms delay setting)

## Polarity

Input to output: non-inverting  
XLR: pin 2 positive with respect to pin 3  
1/4-in. TRS: tip positive with respect to ring

## Operating Voltage

DFR11EQ: 108 to 132 Vac, 50/60 Hz, 50 mA max  
DFR11EQE: 216 to 264 Vac, 50/60 Hz, 25 mA max  
**NOTE:** This product is not disconnected from the mains power supply when the POWER switch is in the Off position.

## Temperature Range

Operating: 0° to 60° C (32° to 140° F)  
Storage: -30° to 70° C (-22° to 158° F)

## Fuse

DFR11EQ: 120 VAC. Fuse: 100 mA, 250V time delay.  
DFR11EQE: 250 VAC. Fuse: 50 mA, 250V time delay  
In order to change a blown fuse, remove the power cord and pry open the drawer with a flathead screwdriver.

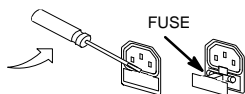

## Dimensions

219 mm x 137 mm x 40 mm  
8 5/8 in x 5 3/8 in x 1 3/4 in

## Weight

930 g (2.5 lbs)

## FEEDBACK FILTERS

Ten (10) 1/10-octave adaptive notch filters from 60 Hz to 20 kHz

Deployed to 1 Hz resolution of feedback frequency

Deployed in depths of 3 dB, 6 dB, 9 dB, 12 dB, and 18 dB (12.5 Low Q in graphic EQ mode) attenuation

Filter shape variable between HI Q and LOW Q (see *High Q vs. Low Q Filters*).

## GRAPHIC EQUALIZER

### Frequency Bands

30 bands on ISO, 1/3-octave centers

### Filter Type

1/3-octave, constant Q

### Maximum Boost

6 dB per band

### Maximum Cut

12dB per band, high- and low-pass filters, 12dB/octave nominal

## PARAMETRIC EQUALIZER

### Frequency Bands

10 bands, variable frequency, variable Q

### Boost/Cut Range

+6 dB to -18 dB per band

### Q Range

1/40-octave to 2 octave

### Shelf/Rolloff Filters

Shelf, +6 to -18 dB per filter  
Rolloff, 6dB, 12dB, 18dB, or 24dB per octave nominal

## DELAY

Up to 100 ms

## FURNISHED ACCESSORIES

Power Cable (DFR11EQ) .....	95A8389
Power Cable (DFR11EQE) .....	95A8247
5-pin DIN Shure Link Cable .....	95A8676
Single Mount Rack Bracket .....	53A8450
Dual Mount Rack Bracket .....	53B8442
Straddle Bars .....	53B8443

**CERTIFICATIONS**

DFR11EQ: UL Listed and cUL Listed to UL 813 and CSA C22.2 No. 1. Authorized under Verification provision of FCC Part 15 as a Class B Digital Device. DFR11EQE: Conforms to European Union Directives, eligible to bear CE marking. Meets European Union Low Voltage Requirements: VDE GS-Certified to EN 60 950. Meets European Union EMC Emissions Requirements: EN 50 081-1 (1992) [EN 55022]. Meets European Union EMC Immunity Requirements EN 50 082-1 (1992): [RF radiated (IEC 801-3) meets Criterion A; ESD meets Criterion B; EFT (IEC 801-4) meets Criterion B].

**INFORMATION TO USER**

Changes or modifications not expressly approved by Shure Brothers Inc. could void your authority to operate this equipment. This equipment has been tested and found to comply with the limits for a Class B digital device, pursuant to Part 15 of the FCC Rules. These limits are designed to provide reasonable protection against harmful interference in a residential installation. This equipment generates, uses and can radiate radio frequency energy and, if not installed and used in accordance with the instructions, may cause harmful interference to radio communications. However, there

is no guarantee that interference will not occur in a particular installation. If this equipment does cause harmful interference to radio or television reception, which can be determined by turning the equipment off and on, the user is encouraged to try to correct the interference by one or more of the following measures:

- Reorient or relocate the receiving antenna.
- Increase the separation between the equipment and receiver.
- Connect the equipment into an outlet on a circuit different from that to which the receiver is connected.
- Consult the dealer or an experienced radio/TV technician for help.



This symbol indicates that dangerous voltage constituting a risk of electric shock is present within this unit.



This symbol indicates that there are important operating and maintenance instructions in the literature accompanying this unit.

# APPENDIX B. RACK MOUNTING THE DFR11EQ

The DFR11EQ comes in a 1/2-rack chassis specially designed for sturdiness. The sagging and bending found in most 1/2-rack designs is eliminated — the brackets and straddle bars are designed to ensure that the units will be installed securely.

**WARNING:** Do not torque the screws too tightly, or the chassis may be damaged.

## Single Unit

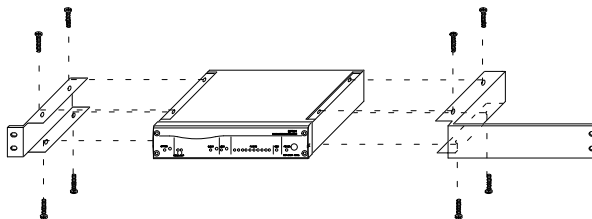

1. Align the supplied rack-mount brackets over the holes.
2. Fasten with the 8 supplied screws.

## Dual-Mounted Units

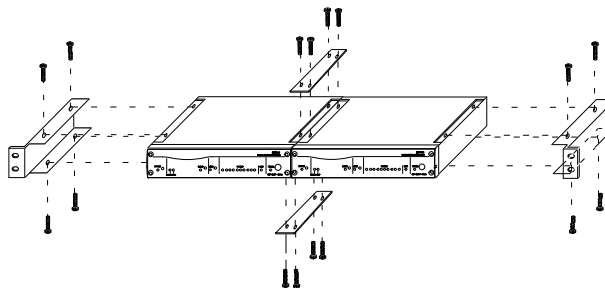

1. Align two units side by side so that the front panels both face the same direction.
  2. Place the supplied straddle bars in the recesses on the top and bottom of the units, so that they overlap both. Fasten with the supplied screws.
- NOTE:** Be sure to use both straddle bars when installing dual units.
3. Position the rackmount brackets over the holes in the side of the unit. Fasten with the supplied screws.

## Mounting in an Equipment Rack



1. Insert the unit(s) into a 19-inch equipment rack.
2. Fasten the unit(s) to the rack using all four of the supplied screws.

# APPENDIX C. CONNECTORS AND CABLES

**NOTE:** Except for the Shure Link cable, none of the cables shown come supplied with the DFR11EQ.

## Audio Connectors

### DFR11EQ Audio Input

<b>Connector:</b> (XLR and 1/4-inch combined)	XLR (female)	1/4-inch phone plug (female)
<b>Configuration:</b>	active balanced	active balanced
<b>Actual Impedance:</b>	47 kΩ	47 kΩ
<b>Nominal Input Level:</b>	+4 dBu (+4 input level) -10 dBV (-10 input level)	+4 dBu (+4 input level) -10 dBV (-10 input level)
<b>Maximum Input Level:</b>	+18 dBu (+4 input level) +6 dBV (-10 input level)	+18 dBu (+4 input level) +6 dBV (-10 input level)
<b>Pin Assignments:</b>	Pin 1 = ground Pin 2 = hot Pin 3 = cold	Tip = hot ring = cold sleeve = ground
<b>Voltage / Current/ Phantom Power Protection?</b>	yes	yes

### DFR11EQ Audio Output

<b>Connector:</b> (XLR and 1/4-inch separate)	XLR (male)	1/4-inch phone plug (female)
<b>Configuration:</b>	active balanced cross coupled	active balanced cross coupled
<b>Actual Impedance:</b>	120 Ω	120 Ω
<b>Nominal Output Level:</b>	+4 dBu (+4 output level) -10 dBV (-10 output level)	+4 dBu (+4 output level) -10 dBV (-10 output level)
<b>Maximum Output Level:</b>	+18 dBu (+4 output level) +6 dBV (-10 output level)	+18 dBu (+4 output level) +6 dBV (-10 output level)
<b>Pin Assignments:</b>	Pin 1 = ground Pin 2 = hot Pin 3 = cold	Tip = hot ring = cold sleeve = ground
<b>Voltage / Current/ Phantom Power Protection?</b>	yes	yes

## Audio Cables

The variety of connectors on audio equipment sometimes leads to confusion in cabling. The diagrams below provide cabling recommendations for most common cabling situations. The following is not a complete list, only a sample of some of the more commonly used cables and applications. Some of the equipment in a given sound system may have different pinouts than the given examples. Consult the documentation for that equipment.

### XLR (male) to XLR (female)

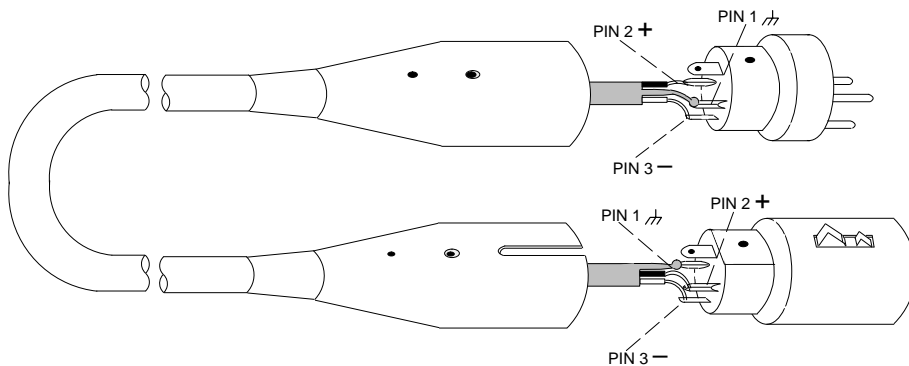

#### TYPICAL APPLICATIONS

- Mixer Line Out to DFR11EQ Input
- DFR11EQ Output to Amplifier Input
- DFR11EQ Output to Mixer Sub Return
- Mixer Send to DFR11EQ Input
- Mixer Sub Send to DFR11EQ Input
- DFR11EQ Output to Mixer Sub Return

### 1/4-in. to 1/4-in. Balanced

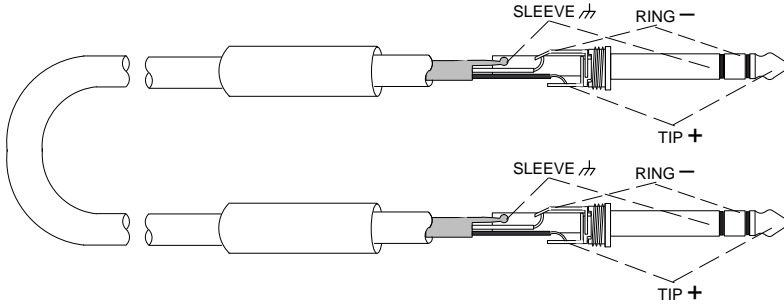

**TYPICAL APPLICATIONS**

- Mixer Line Out to DFR11EQ Input
- DFR11EQ Output to Amplifier Input
- DFR11EQ Output to Mixer Sub Return
- Mixer Send to DFR11EQ Input
- Mixer Sub Send to DFR11EQ Input
- DFR11EQ Output to Mixer Sub Return

### 1/4-in. to 1/4-in. Unbalanced

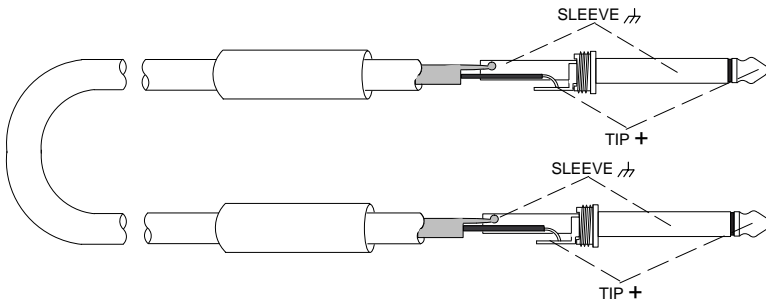

**TYPICAL APPLICATIONS**

- Mixer Line Out to DFR11EQ Input
- DFR11EQ Output to Amplifier Input
- DFR11EQ Output to Mixer Sub Return
- Mixer Send to DFR11EQ Input
- Mixer Sub Send to DFR11EQ Input
- DFR11EQ Output to Mixer Sub Return

### 1/4-in. Balanced to 1/4-in. Unbalanced

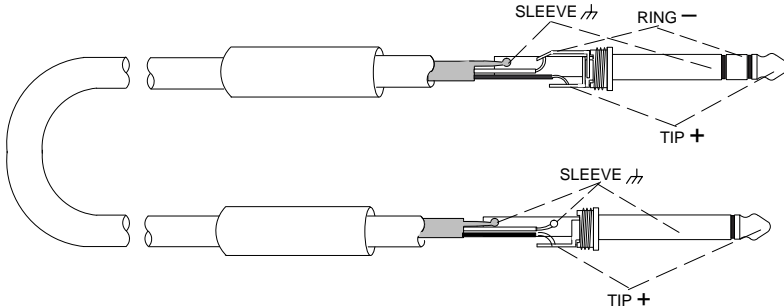

**TYPICAL APPLICATIONS**

- Mixer Line Out to DFR11EQ Input
- DFR11EQ Output to Amplifier Input
- DFR11EQ Output to Mixer Sub Return
- Mixer Send to DFR11EQ Input
- Mixer Sub Send to DFR11EQ Input
- DFR11EQ Output to Mixer Sub Return

### XLR (male) to 1/4-in. Balanced

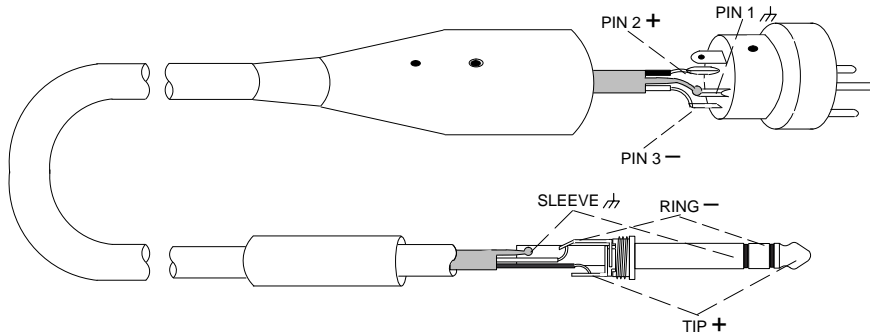

**TYPICAL APPLICATIONS**

- Mixer Line Out to DFR11EQ Input
- DFR11EQ Output to Amplifier Input
- DFR11EQ Output to Mixer Sub Return
- Mixer Send to DFR11EQ Input
- Mixer Sub Send to DFR11EQ Input
- DFR11EQ Output to Mixer Sub Return



### XLR (female) to 1/4-in. Balanced

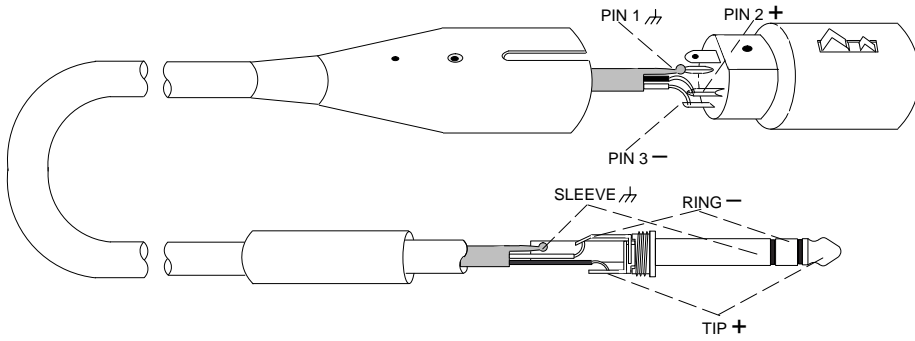

**TYPICAL APPLICATIONS**

- Mixer Line Out to DFR11EQ Input
- DFR11EQ Output to Amplifier Input
- DFR11EQ Output to Mixer Sub Return
- Mixer Send to DFR11EQ Input
- Mixer Sub Send to DFR11EQ Input
- DFR11EQ Output to Mixer Sub Return

### XLR (female) to 1/4-in. Unbalanced

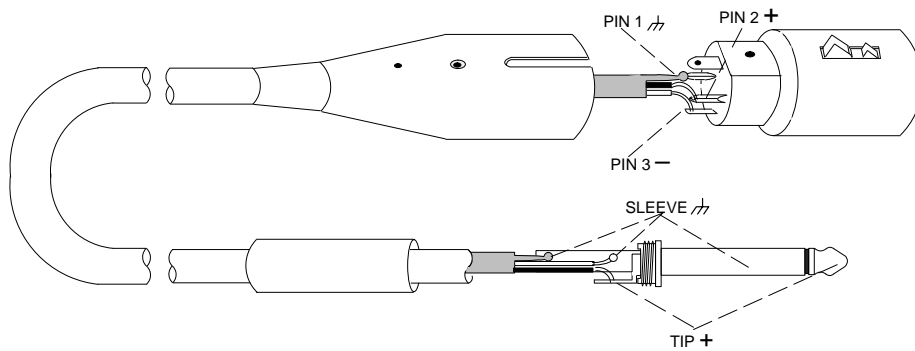

**TYPICAL APPLICATIONS**

- Mixer Line Out to DFR11EQ Input
- DFR11EQ Output to Amplifier Input
- DFR11EQ Output to Mixer Sub Return
- Mixer Send to DFR11EQ Input
- Mixer Sub Send to DFR11EQ Input
- DFR11EQ Output to Mixer Sub Return

### Y-adapter cable, 1/4-in. Balanced to 1/4-in. Unbalanced

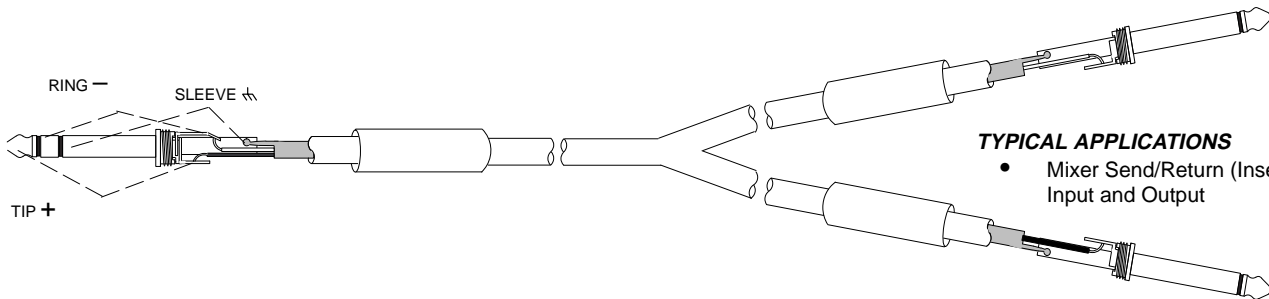

**TYPICAL APPLICATIONS**

- Mixer Send/Return (Insert) to DFR11E Input and Output

### RCA to 1/4-in. Unbalanced

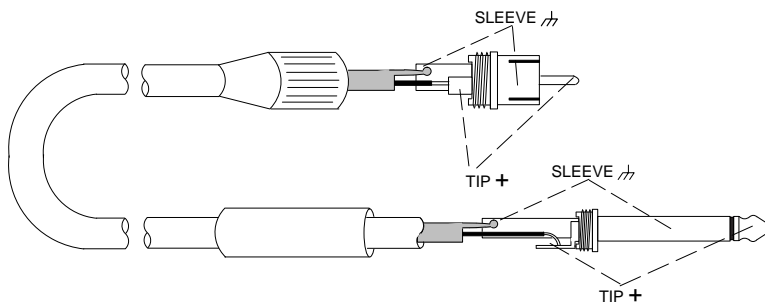

**TYPICAL APPLICATIONS**

- DFR11EQ Output to Amplifier Input

# Digital Connectors and Cables

## Computer Interface — 9-Pin to 9-Pin RS-232 Cable

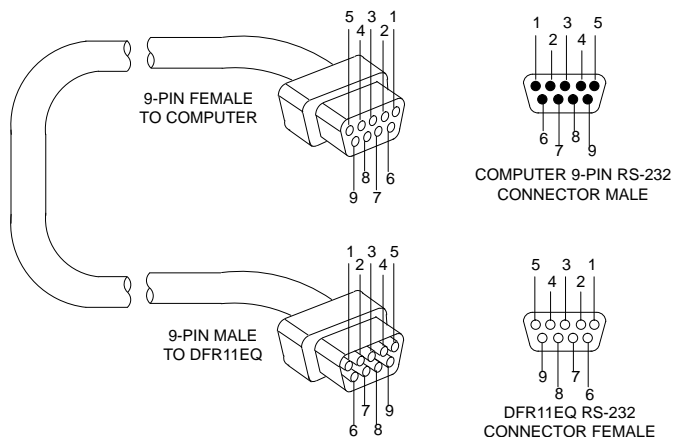

FUNCTION	PIN #
—	1
RX	2
TX	3
DTR	4
GND	5
DSR	6
RTS	7
CTS	8
—	9

## Computer Interface — 9-Pin to 25-Pin RS-232 Cable

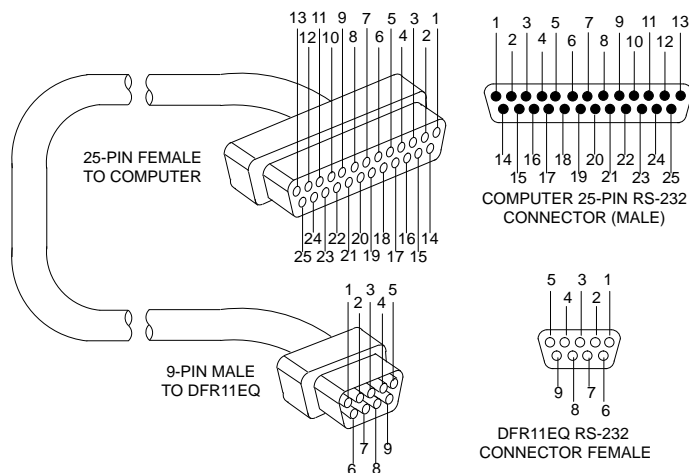

FUNCTION	9-PIN CONNECTOR PIN #	25-PIN CONNECTOR PIN #
—	1	8
RX	2	3
TX	3	2
DTR	4	20
GND	5	7
DSR	6	6
RTS	7	4
CTS	8	5
—	9	22

## Shure Link Cable — 5-Pin DIN Cable (MIDI-compatible cable)

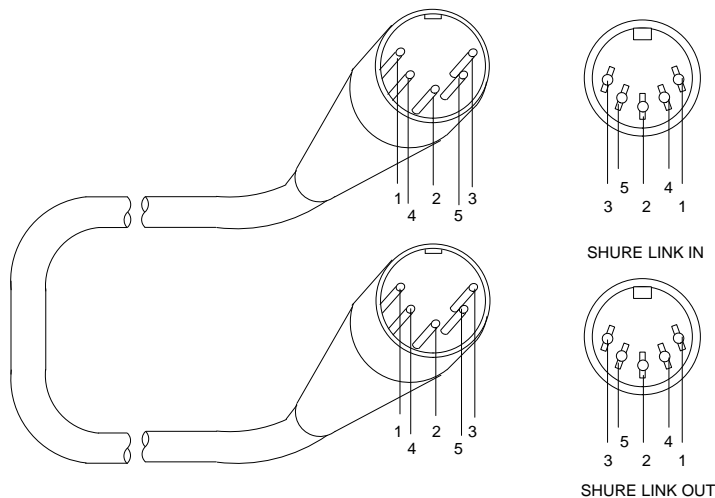

FUNCTION	PIN #
—	1
DATA	4
SHIELD	2
DATA	5
—	3

# APPENDIX D. KEYBOARD CONTROLS

There are a number of keyboard controls which you can use in instead of a mouse.

## General Controls

HIGHLIGHT controls from left to right:



HIGHLIGHT controls from right to left:

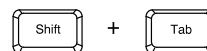

PRESS a selected button:

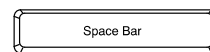

SAVE a scene:

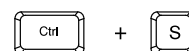

RECALL a scene:

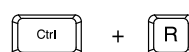

PRINT the settings of the current unit:

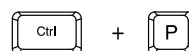

EXIT the program:

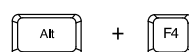

FINE ADJUST a parameter:

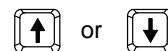

COARSE ADJUST a filter or slider:

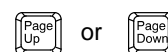

UNDO a clear or flat action:

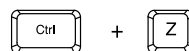

DELETE a highlighted text:



COPY highlighted text to the clipboard:

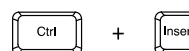

CUT highlighted text to the clipboard:

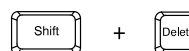

PASTE text from the clipboard:

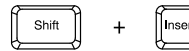

## IN/OUT Meters and OUTPUT Slider Controls

RESET the OUTPUT slider:

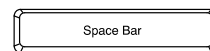

Turn the IN/OUT meters ON and OFF:

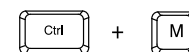

FINE ADJUST the output gain:

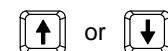

COARSE ADJUST the output gain:



## Graphic Equalizer Controls

HIGHLIGHT the sliders from left to right:

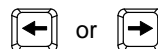

RESET a selected slider:

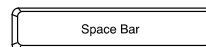

FINE ADJUST the gain of a selected slider:

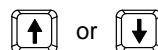

COARSE ADJUST the gain of a selected slider:

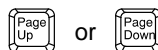

## Parametric Equalizer Controls

RESET a selected parametric filter:

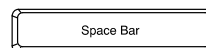

CREATE a new parametric filter:



FINE ADJUST the FREQUENCY of a parametric filter:

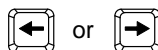

COARSE ADJUST the FREQUENCY of a parametric filter:



FINE ADJUST the GAIN of a parametric filter:

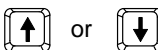

COARSE ADJUST the GAIN of a parametric filter:

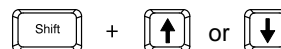
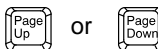

ADJUST the WIDTH of a parametric filter:



CUT a parametric filter:

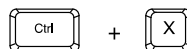

COPY a parametric filter:

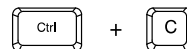

PASTE a parametric filter:

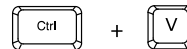

DELETE a parametric filter:



---

---

# **NOTES**